

Collectieve RVS muurwasgoot voor 4 gebruikers

2400 mm x 490 mm x 430 mm

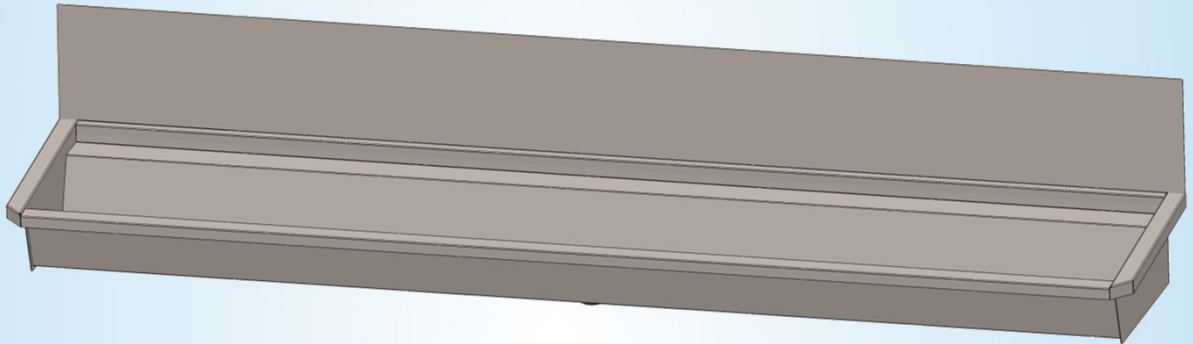

3.0-4-Z1

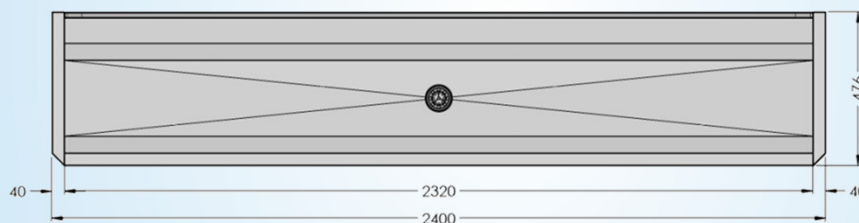
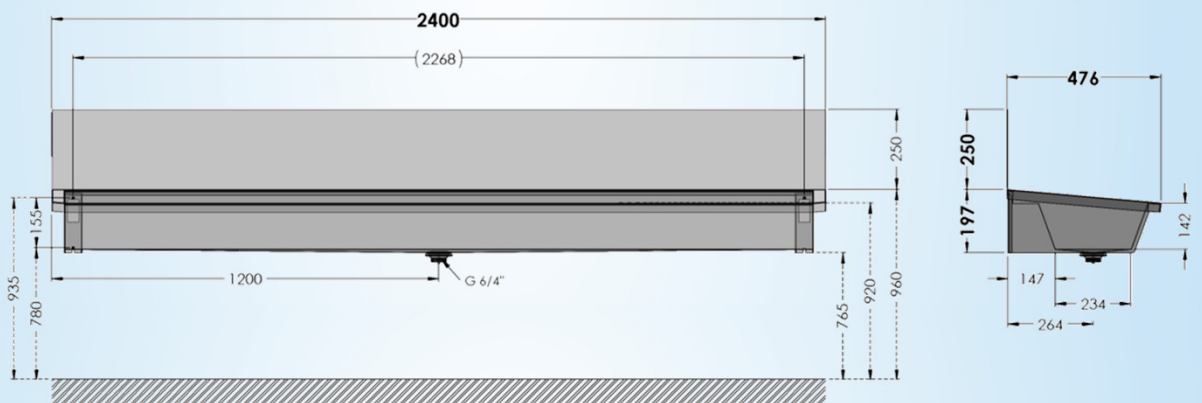

Logistieke gegevens :

gewicht
1 colli

netto: 27 kg

bruto: 31 kg

Sanilav®

Technische Fiche

Montage-instructies – Instructions de montage Mounting Instructions – Montage Anleitung

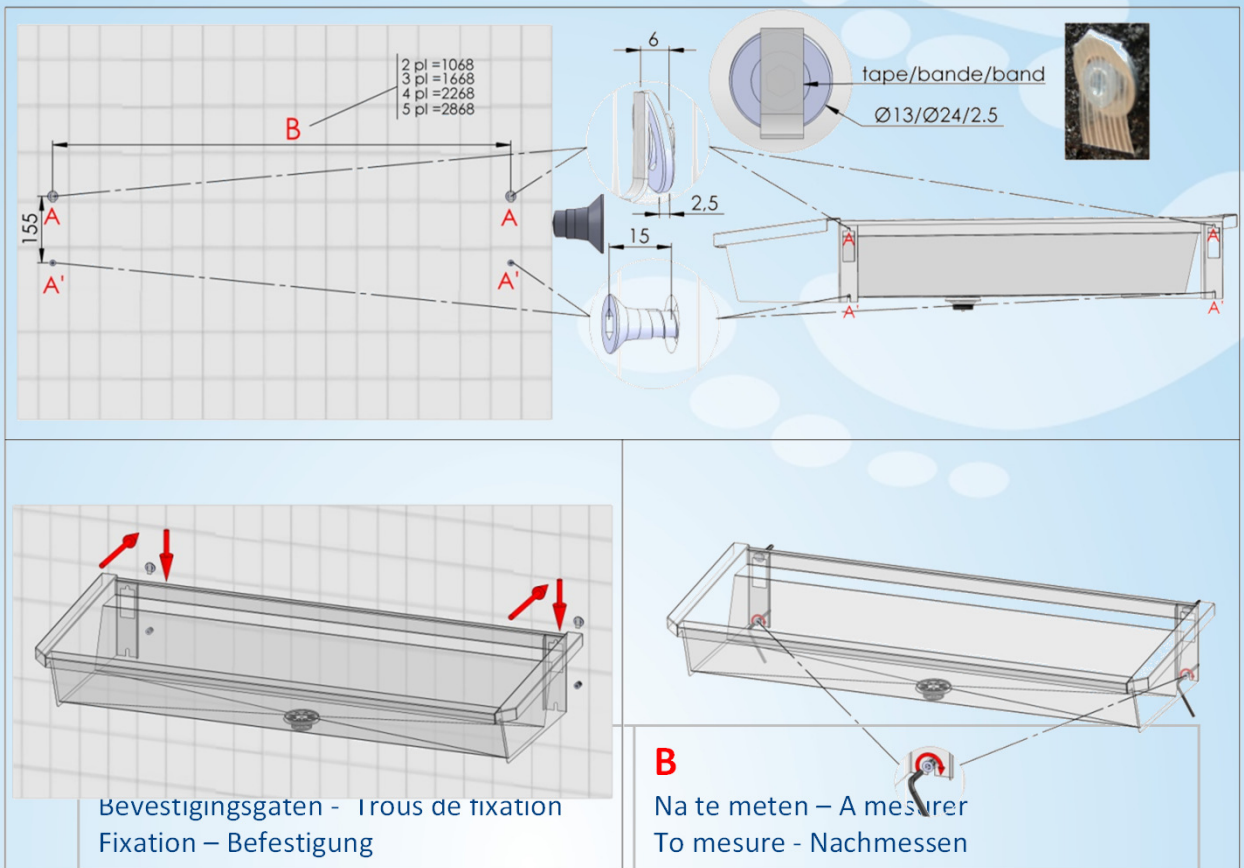

Aansluitingschema – Instructions de raccordement Water connection Instructions – Wasseranschluss Anleitung

C : WATERAANSLUITING / RACCORDEMENT D'EAU / WATERCONNECTION / WASSERANSCHLUSS

