

MONTAGEVOORSCHRIFT
MONTAGE - ANLEITUNG

MOUNTING INSTRUCTIONS
INSTRUCTIONS DE MONTAGE

ZV-A

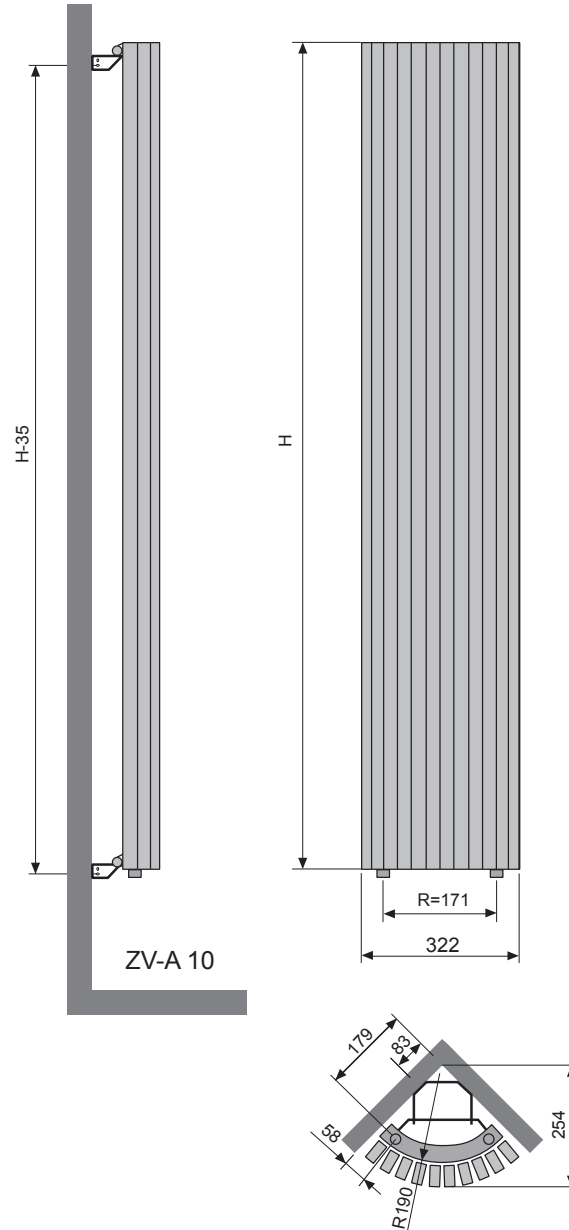
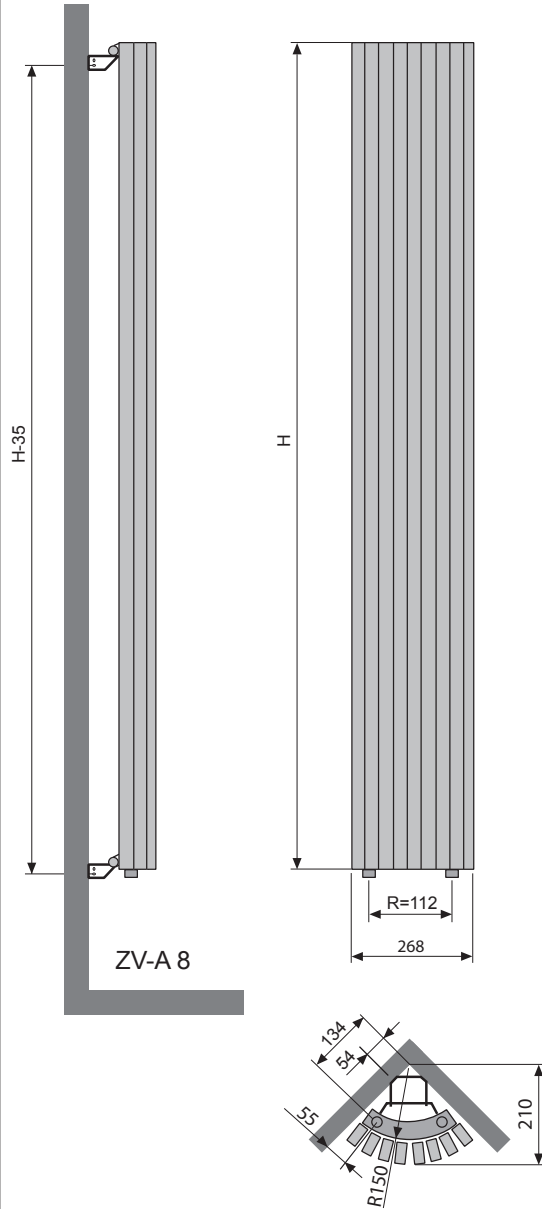

Werkdruk : Max.4bar
Betriebsdruck : Max.4bar
Pression de service : Max.4bar
Operating pressure : Max.4bar

Controleer of de wand voldoende draagvermogen heeft.
Kies de geschikte schroeven en pluggen in functie van de wand.
Uw vakhandel kan u hierbij adviseren.
Hou rekening met eventuele bijzondere eisen, zoals
bv. voor openbare gebouwen.

NL

Vérifier la capacité de charge du support.
Pour des raisons de sécurité, les chevilles et vis ne sont pas fournies.
Contactez votre revendeur pour choisir le bon type de chevilles / vis.
Tenir compte des exigences spéciales,
comme par exemple pour des bâtiments publics.

F

Untergrund auf Tragfähigkeit prüfen.
Aus Sicherheitsgründen werden keine Dübel und Schrauben mitgeliefert.
Kontaktieren Sie Ihren Händler für die richtigen Dübel / Schrauben.
Spezielle Anforderungen, wie z. B. für öffentliche Gebäude,
berücksichtigen.

D

Check the bearing surface for load-carrying capacity.
For safety reasons wall plugs and screws aren't delivered.
Contact your dealer for the right type of screws / plugs.
Observe special requirements for e.g. public buildings.

E

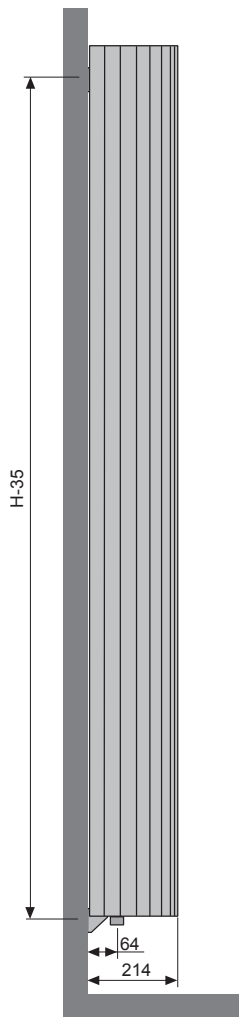
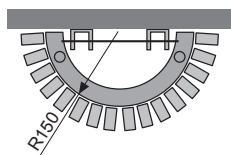
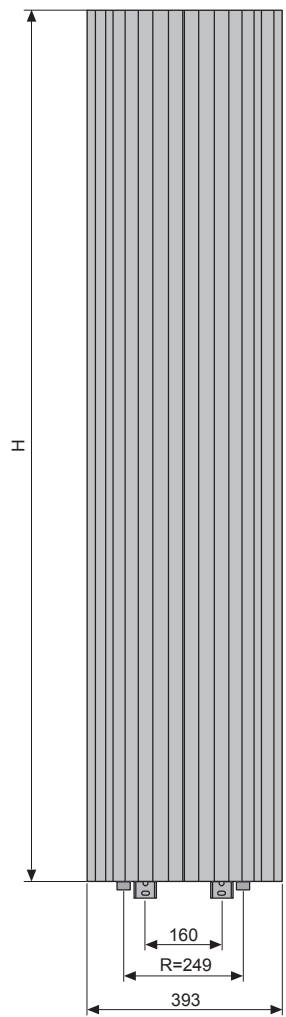

ZV-O 16

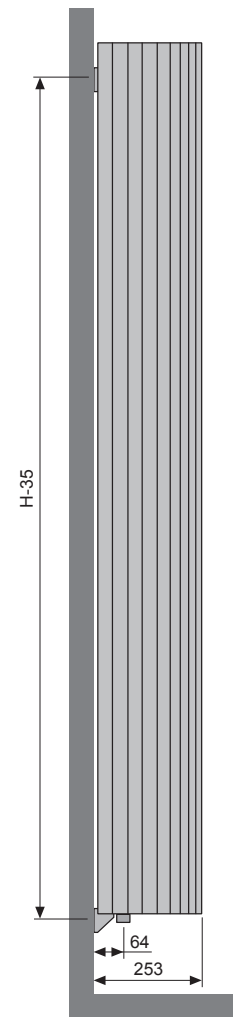
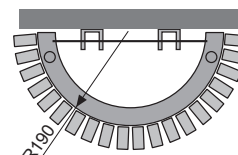
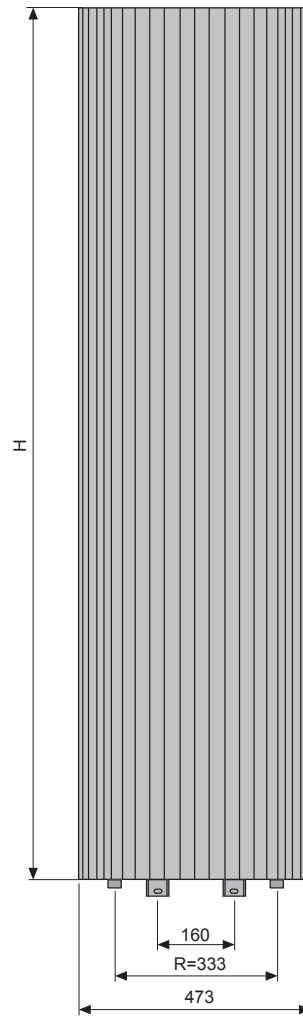

ZV-O 20