

SET LAUFEN PRO S

Double countertop basin 81496.5



TECHNICAL DATA

Order no.	81496.5
Certified to	EN 31
Dimensions	1200 x 470 mm
Inside dimensions of the basin	1140 x 295 mm
matching for	Vanity unit Laufen Pro S, order no. 48356.1, 48356.2
Specification	Charge 104 – 1 centre tap hole
Special specification	Charge 107 – 1 tap hole left, 1 tap hole right Charge 108 – 3 tap holes Charge 109 – without tap hole
Weight	
Accessories excl.	Siphon cover, order no. 81996.3 (2 or 3 tap holes not possible) Pedestal, order no. 81996.2 Towel rack, order no. 38596.3

Mounting acc. excl. 2x Mounting set M10 x 140 mm, order no. 89988.2

Colours see colour table

SPECIFICATION TEXT

Double countertop basin LAUFEN PRO S, sanitary ceramic EN 31, dimensions 1200 x 470 mm, angular 1 centre tap hole

Special feature: overflow channel glazed

Further options / accessories: Surface refinement LCC (only white), 1 tap hole left and right, 3 tap holes, without tap holes, siphon cover, pedestal, towel rack, bathtubs, vanity unit, furniture

Order no. 81496.5

TECHNICAL DRAWINGS / S 1 : 20

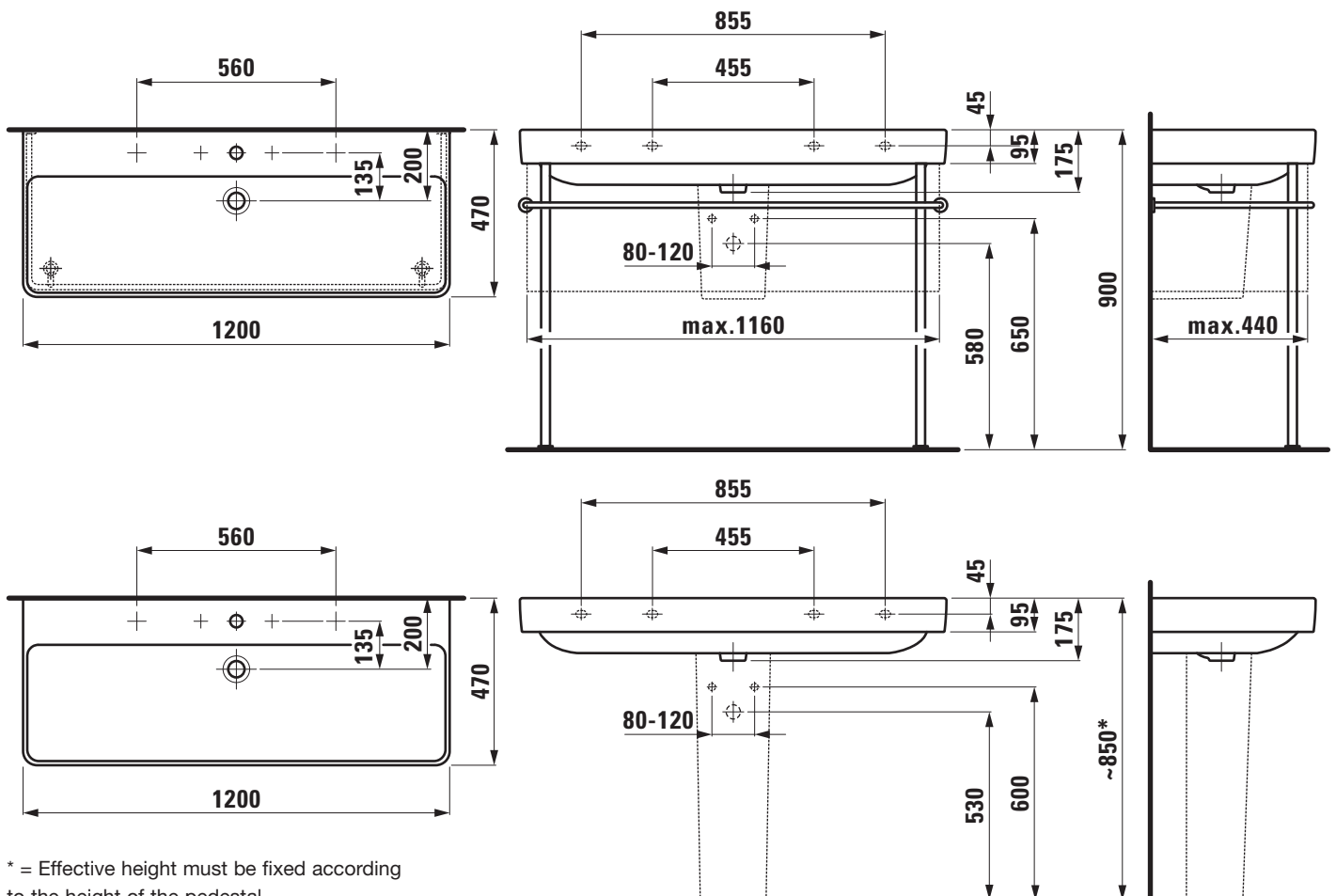

* = Effective height must be fixed according to the height of the pedestal.