

© Copyright by PBO 04/14 1009425

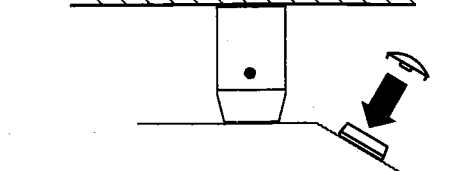

TYPE TO80-H

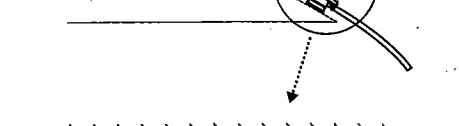
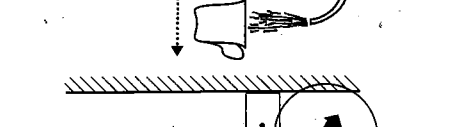
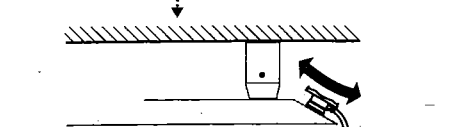
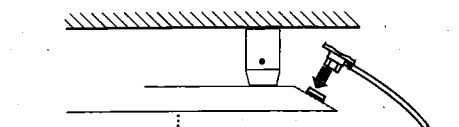
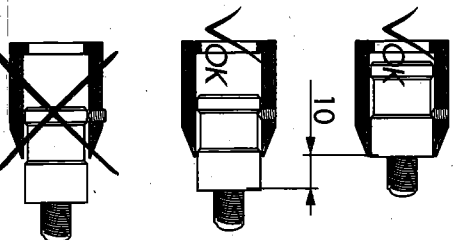
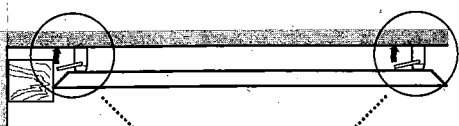
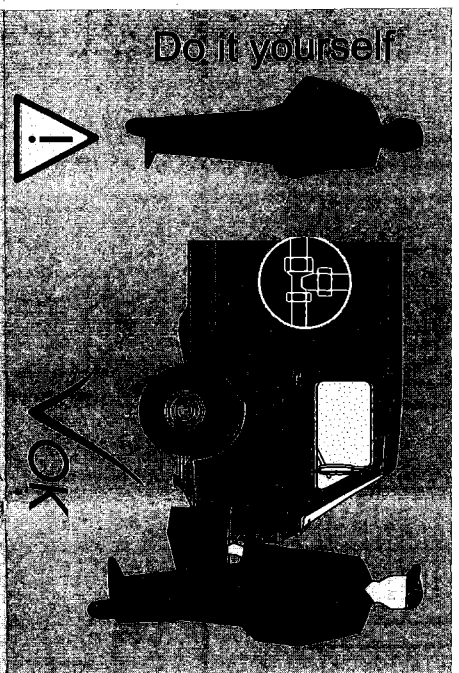
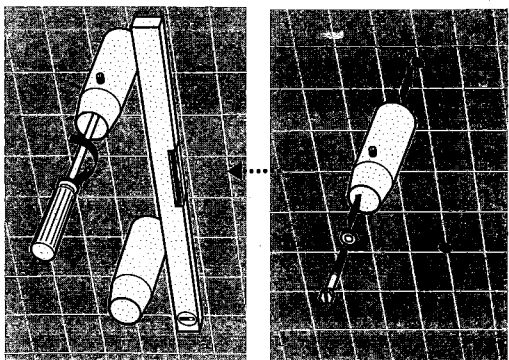
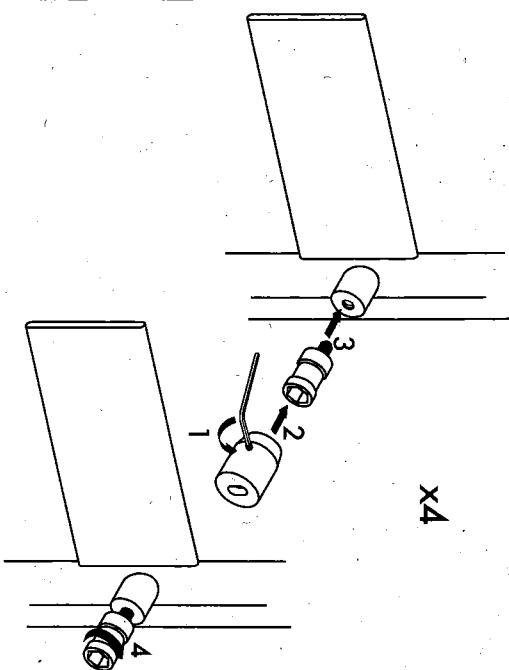
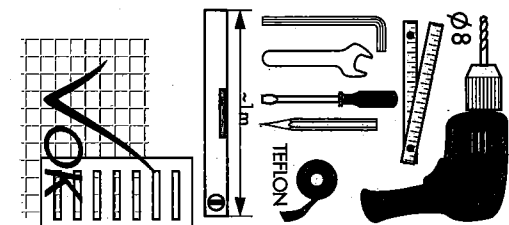
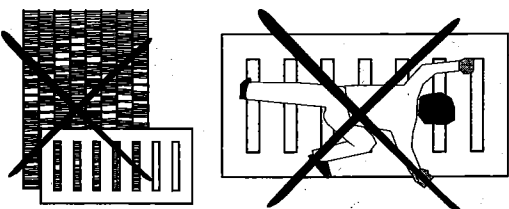
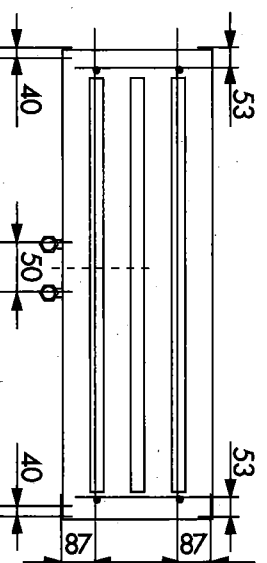
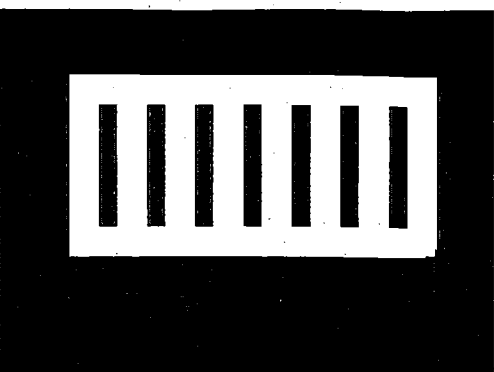

L | 1400 | 1600 | 1800 | 2000

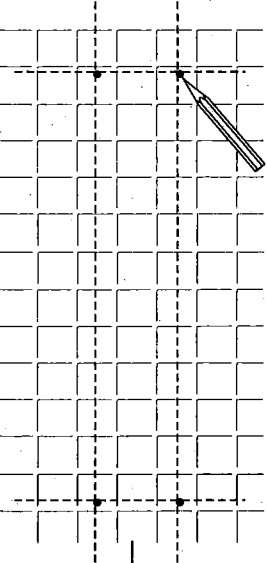
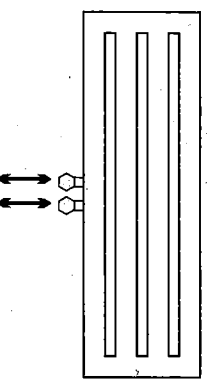

L | 1400 | 1600 | 1800 | 2000

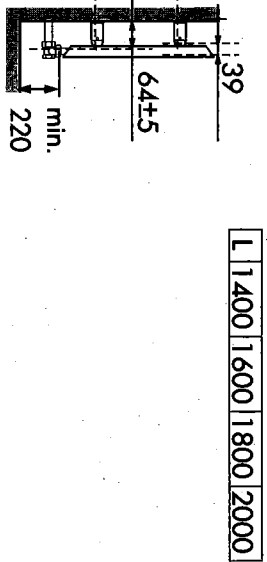
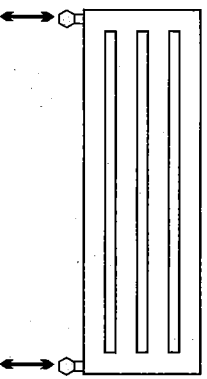

L | 1400 | 1600 | 1800 | 2000

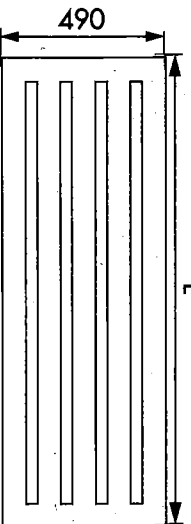

L | 1400 | 1600 | 1800 | 2000

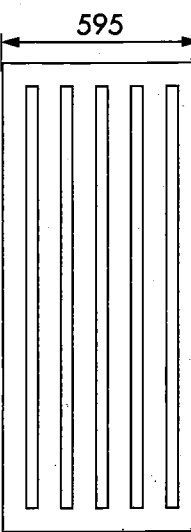

L | 1400 | 1600 | 1800 | 2000

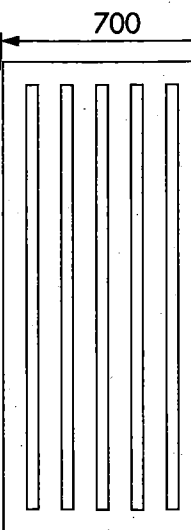

L | 1400 | 1600 | 1800 | 2000

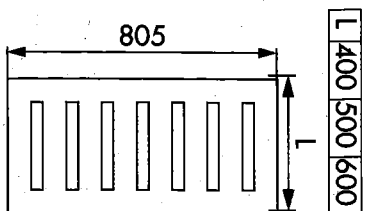
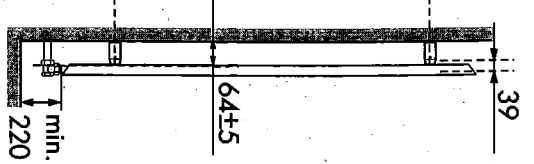
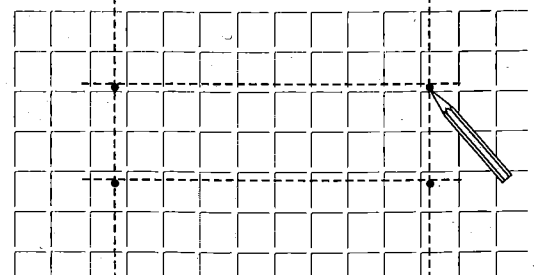
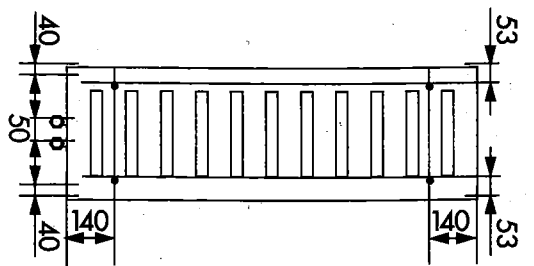
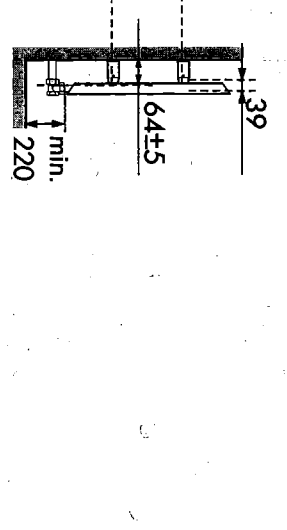
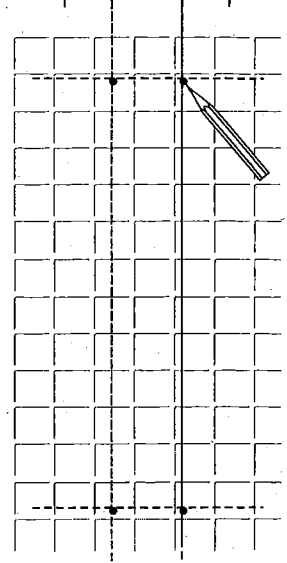
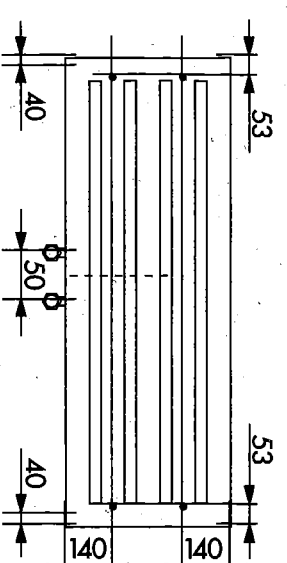

L | 400 | 500 | 600

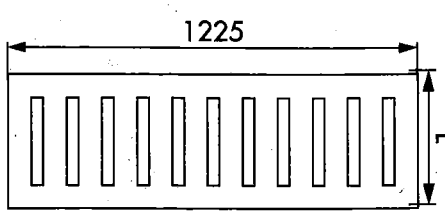

L | 400 | 500 | 600

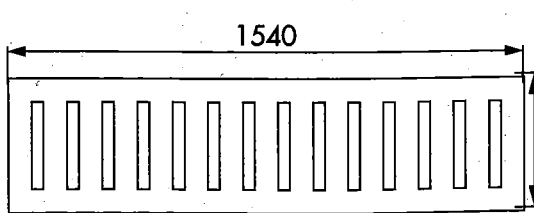

L | 400 | 500 | 600

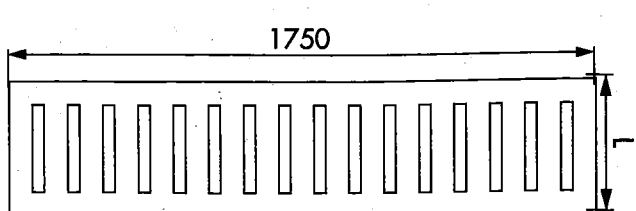

L | 400 | 500 | 600

TYPE T081-H

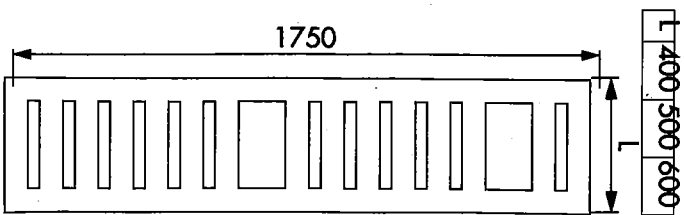
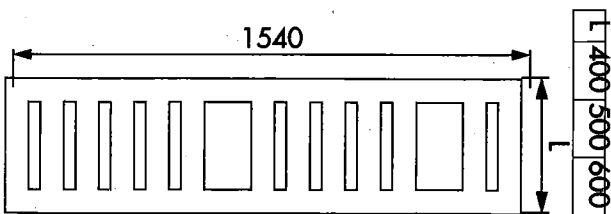
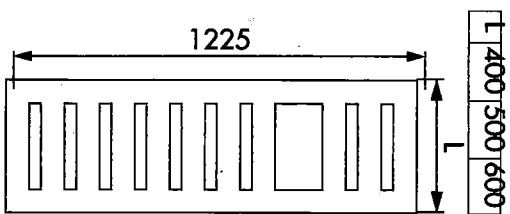
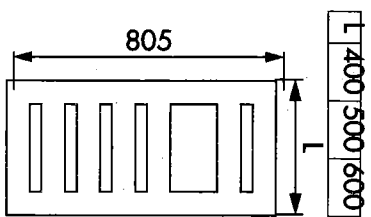
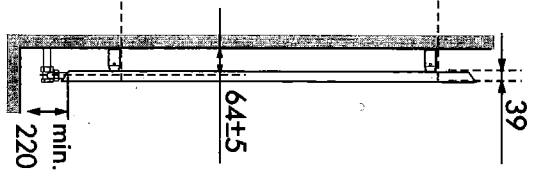
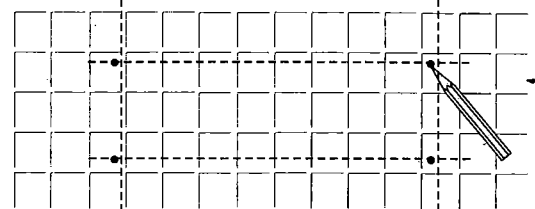
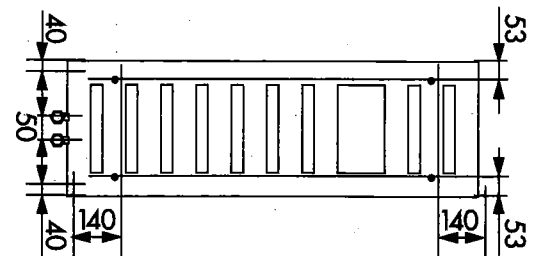
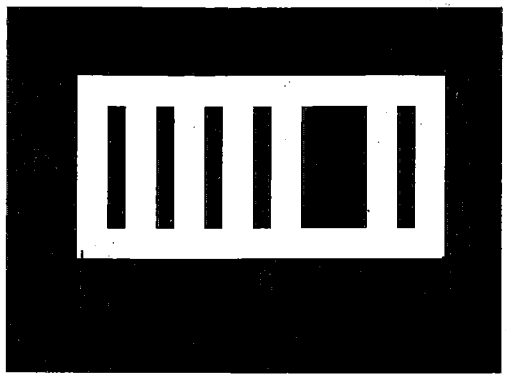

TYPE T080-V

