

# sealskin®

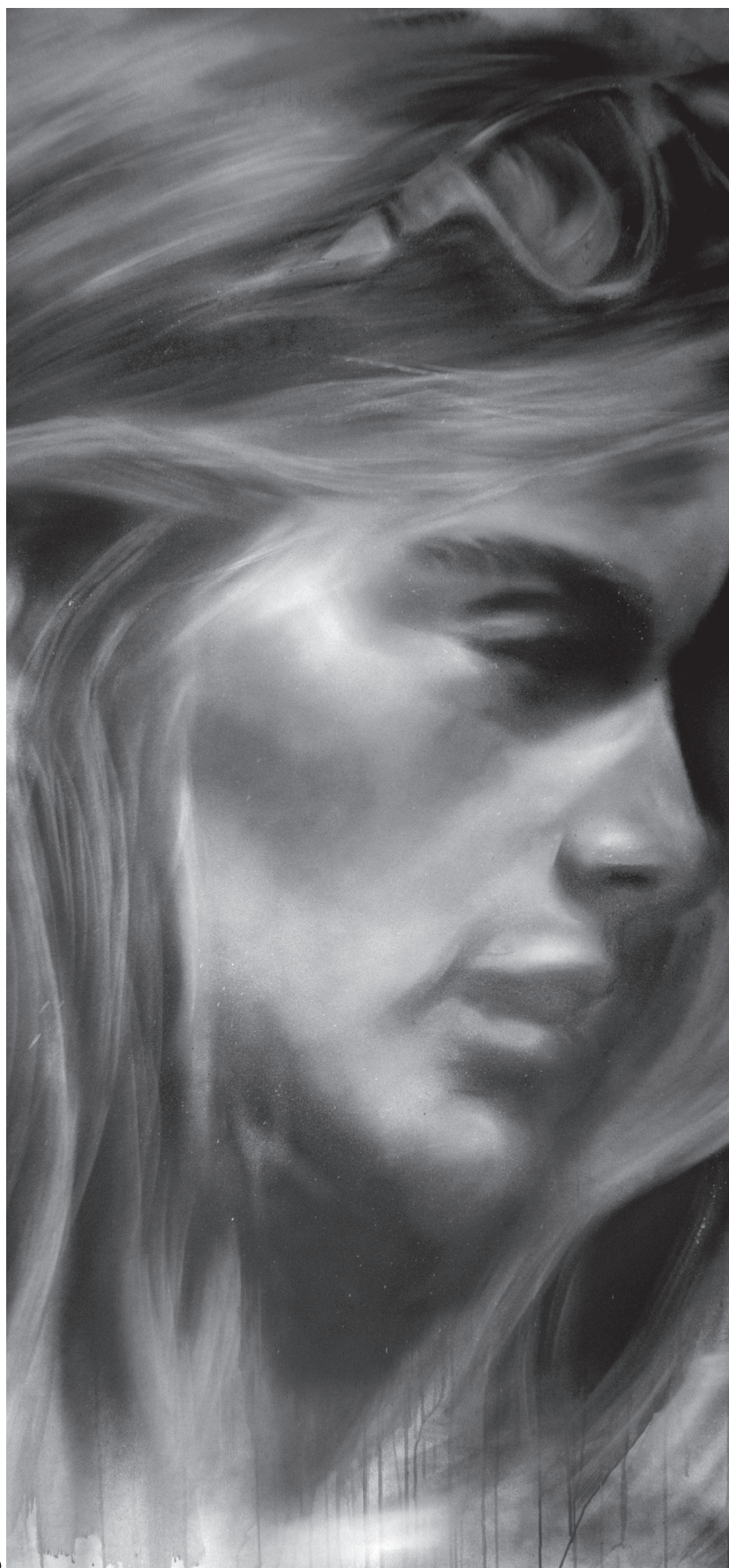

KB19  
KB20  
KB01

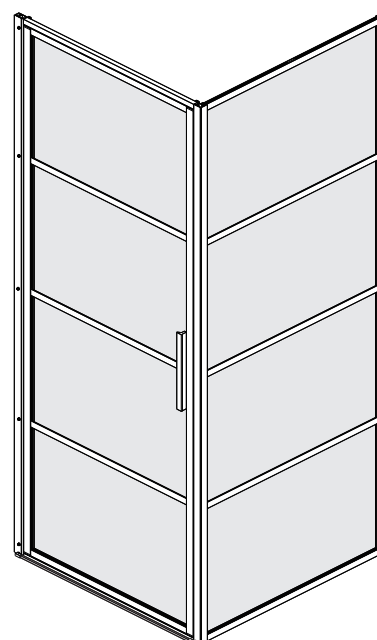
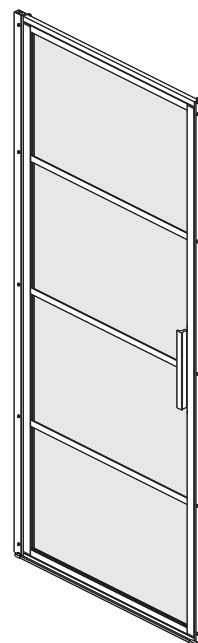

# SOHO

## Included



MUUR PLUG  
CHEVILLE  
WALL ANCHORS



SCHROEVEN  
VIS  
SCREWS

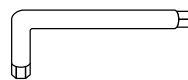

INBUSLEUTEL  
CLÉ ALLEN  
ALLEN KEY

## Additional tools

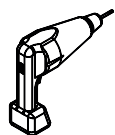

BOOR  
PERCEUSE  
DRILL

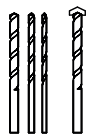

BOOR BITS: 3.0MM, 6.0MM  
FORETS: 3.0MM, 6.0MM  
DRILL BITS: 3.0MM, 6.0MM

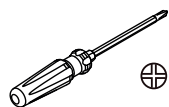

SCHROEVENDRAAIER  
TOURNEVIS  
SCREW DRIVER



SILICONENKIT  
SILICONE  
SILICONE

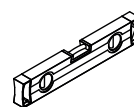

WATERPAS  
NIVEAU  
BUBBLE LEVEL

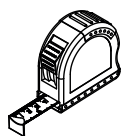

MEETLINT  
RUBAN À MESURER  
MEASURING TAPE



POTLOOD  
CRAYON  
PENCIL

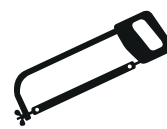

IJZER ZAAG  
SCIE À FER  
METAL SAW

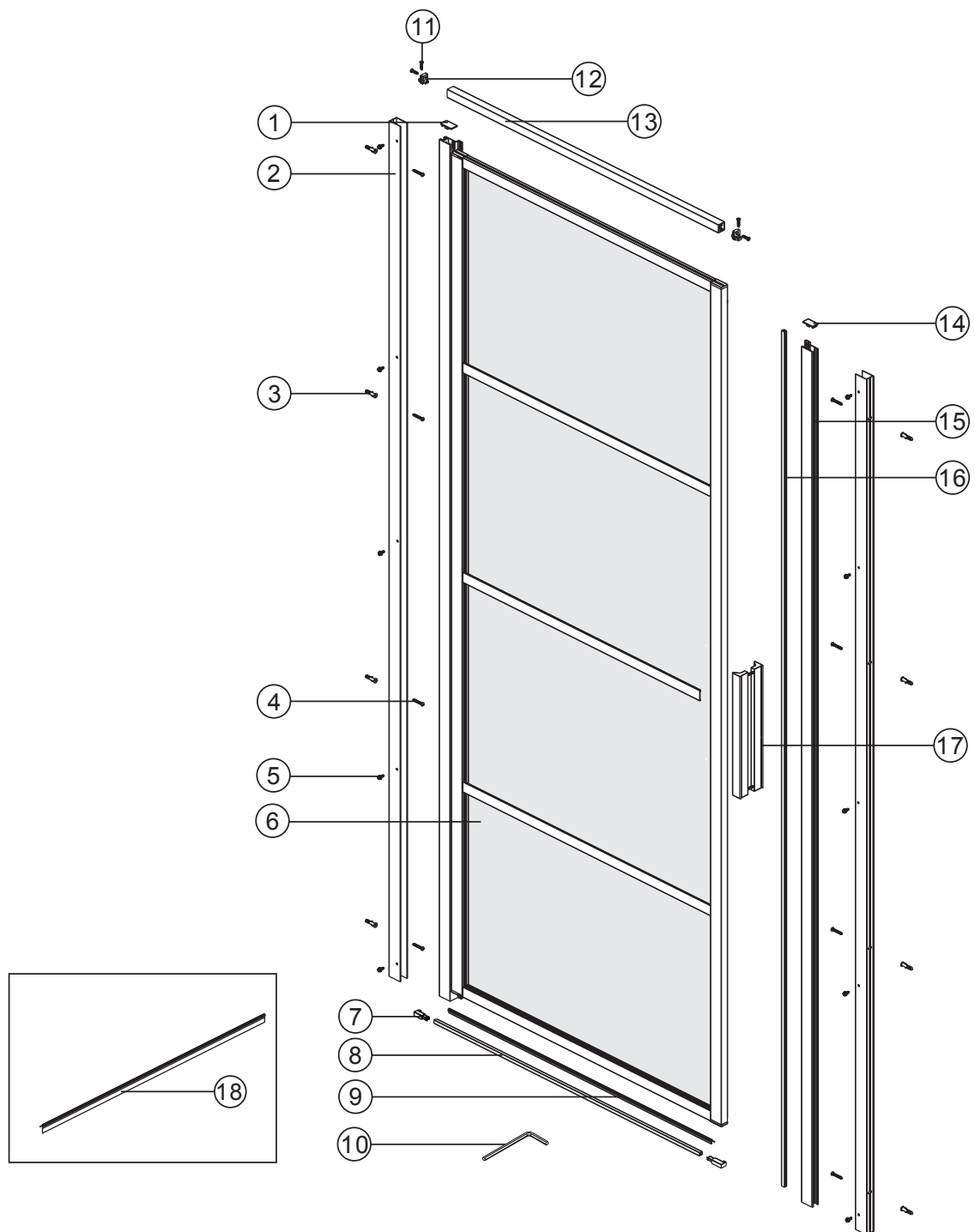

| NO | Qty | Description                       | NO | Qty | Description                           |
|----|-----|-----------------------------------|----|-----|---------------------------------------|
| 1  | 1   | Wall profile top cover            | 10 | 1   | Allen key                             |
| 2  | 2   | Wall profile                      | 11 | 4   | Cross head countersunk screw ST3.5X20 |
| 3  | 8   | Wall anchor                       | 12 | 2   | Bracket for Horizontal bar            |
| 4  | 8   | Cross head screw ST4X30           | 13 | 1   | Horizontal bar                        |
| 5  | 8   | Phillip head hexagon screw ST4X12 | 14 | 1   | Wall profile top cover                |
| 6  | 1   | Door panel                        | 15 | 1   | Magnet profile                        |
| 7  | 2   | Threshold part L/R                | 16 | 1   | Magnet gasket                         |
| 8  | 1   | Back splash                       | 17 | 1   | Handle                                |
| 9  | 1   | Bottom gasket A                   | 18 | 1   | Bottom gasket B                       |

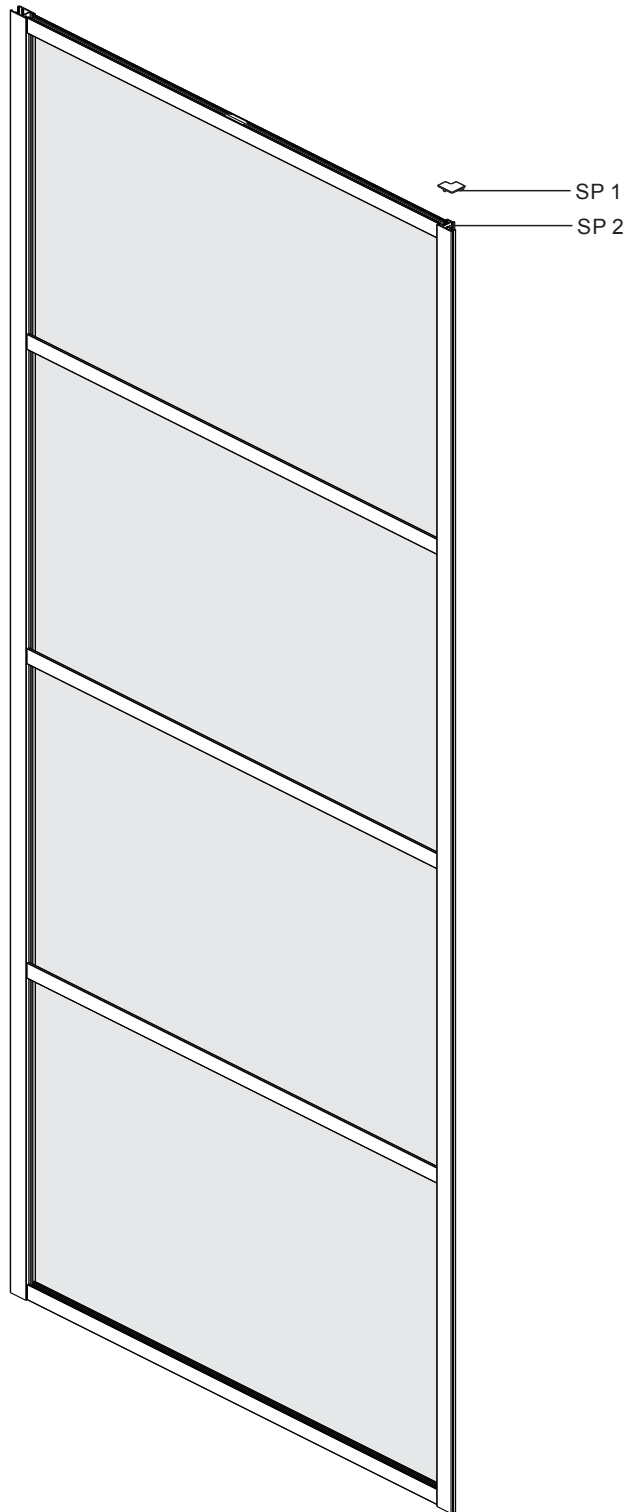

| NO   | Qty | Description              |
|------|-----|--------------------------|
| SP 1 | 1   | Corner profile top cover |
| SP 2 | 1   | Return panel             |

**A** 01

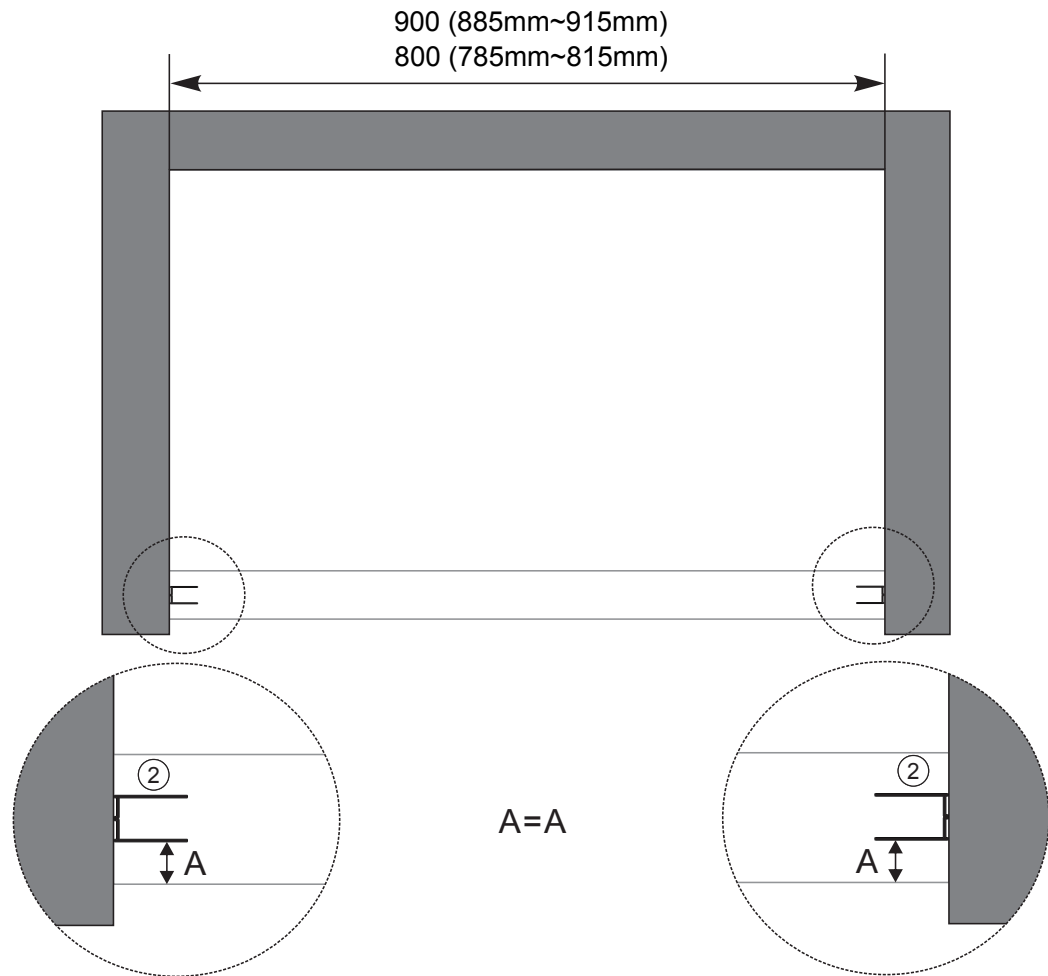

**A** 02

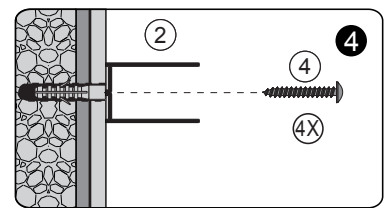
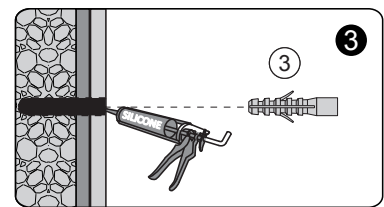
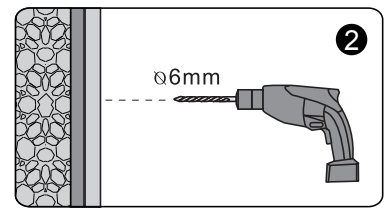
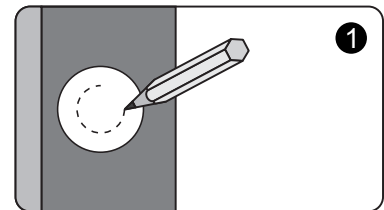
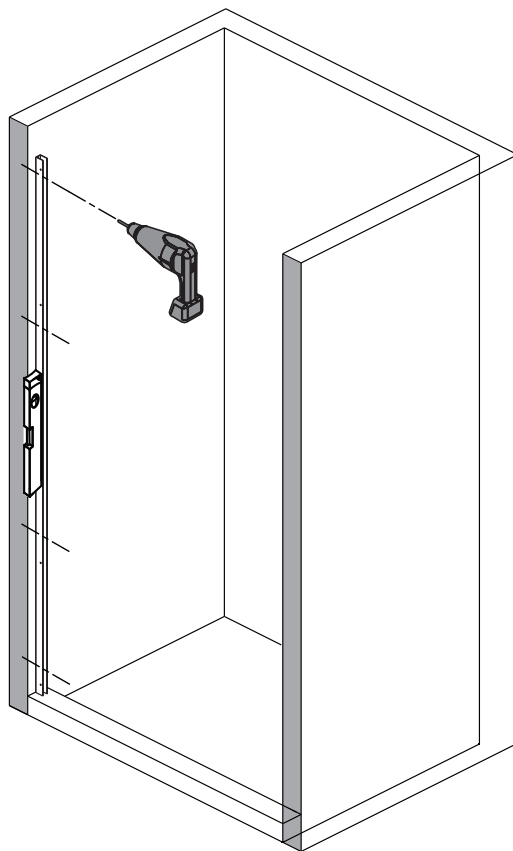

**A** 03

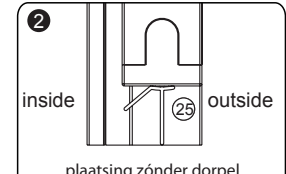
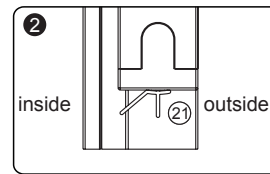
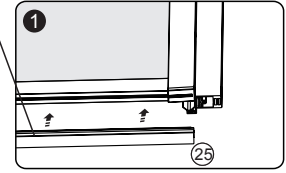
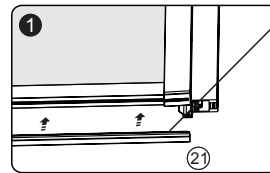
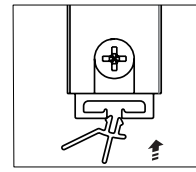
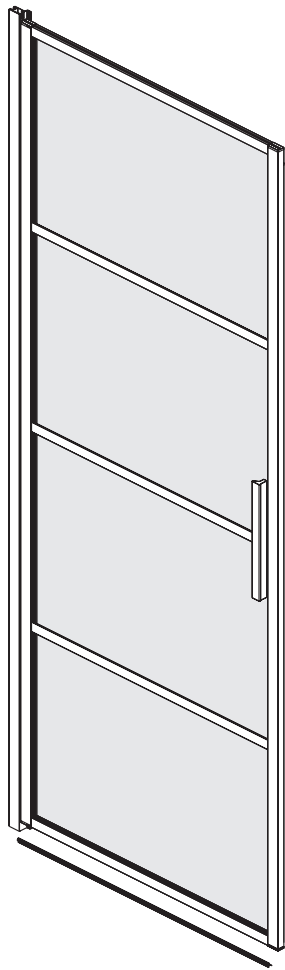

of  
ou  
or

plaatsing zónder dorpel  
placement sans seuil  
mounting without threshold

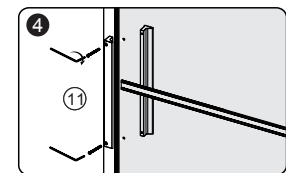
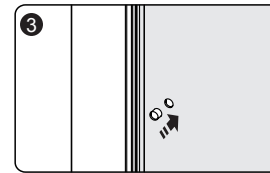

**A** 04

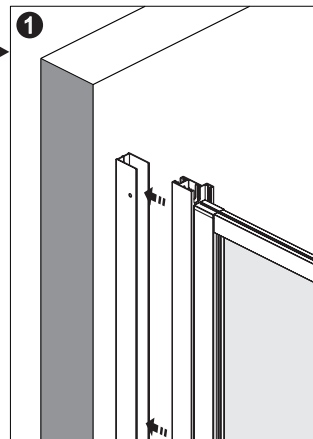
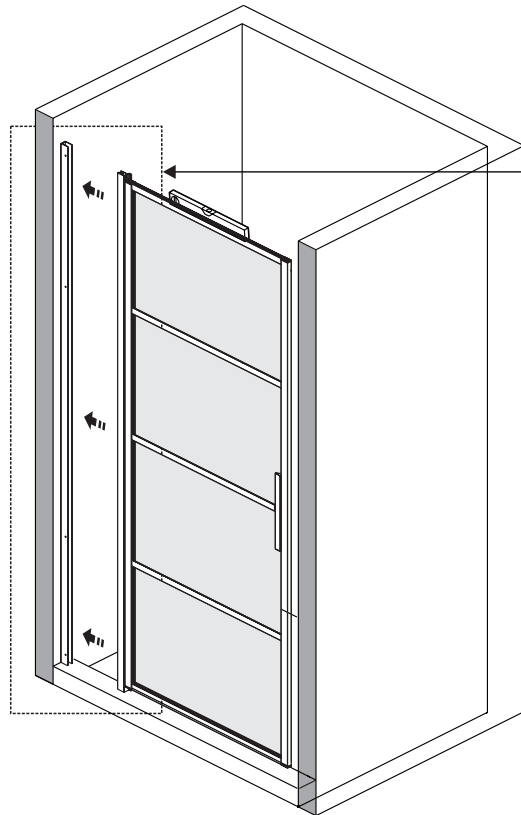

**A** 05

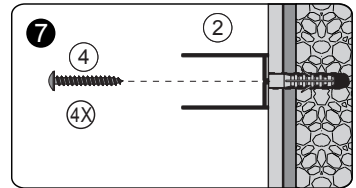
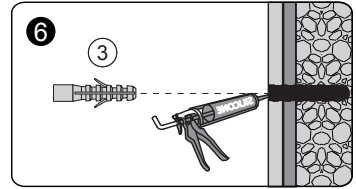
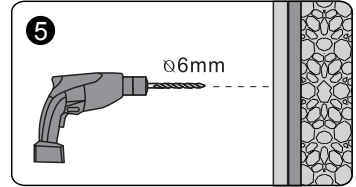
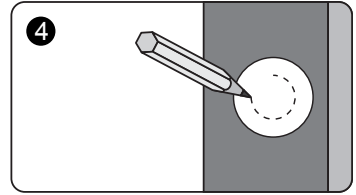
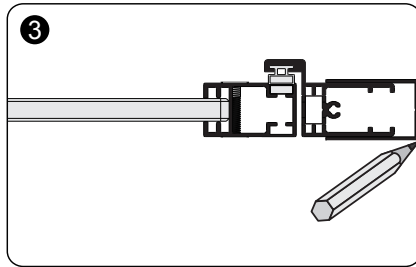
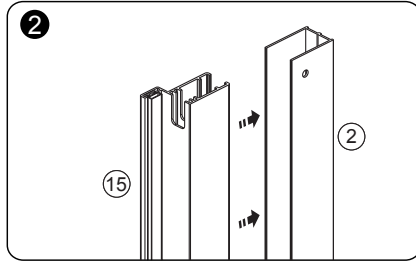
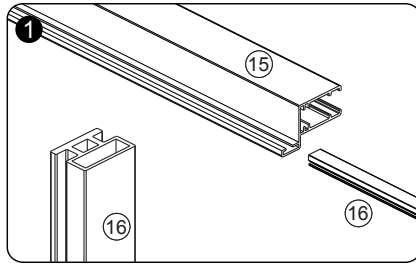
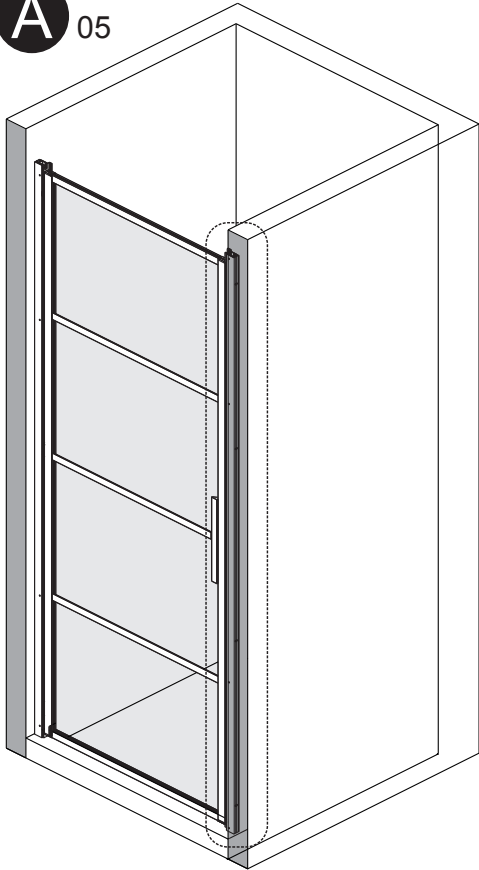

**A** 06

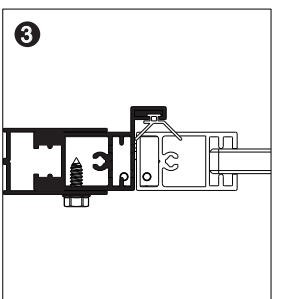
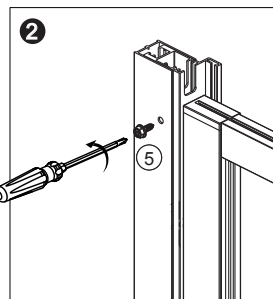
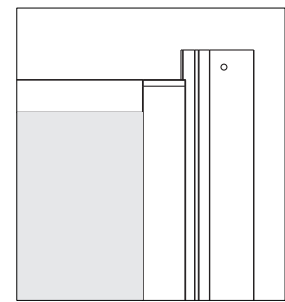
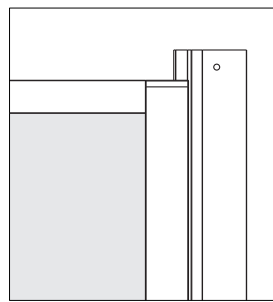
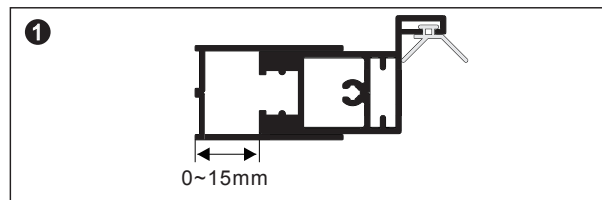
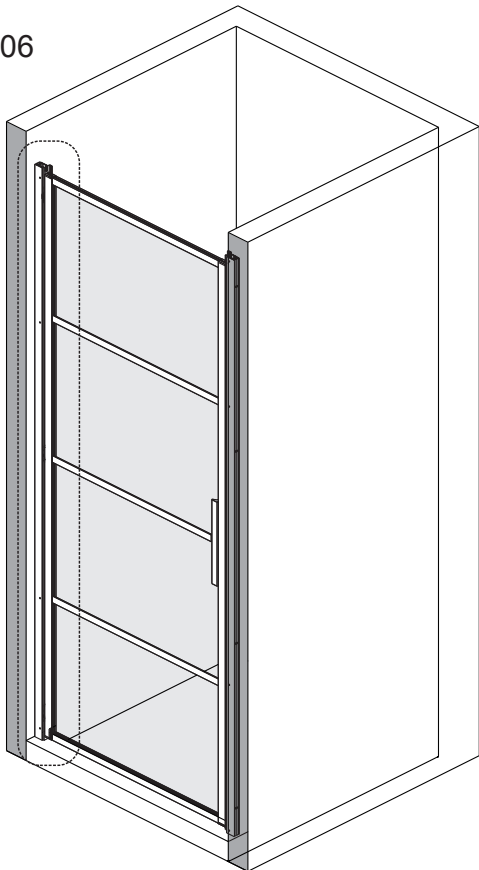

A 07

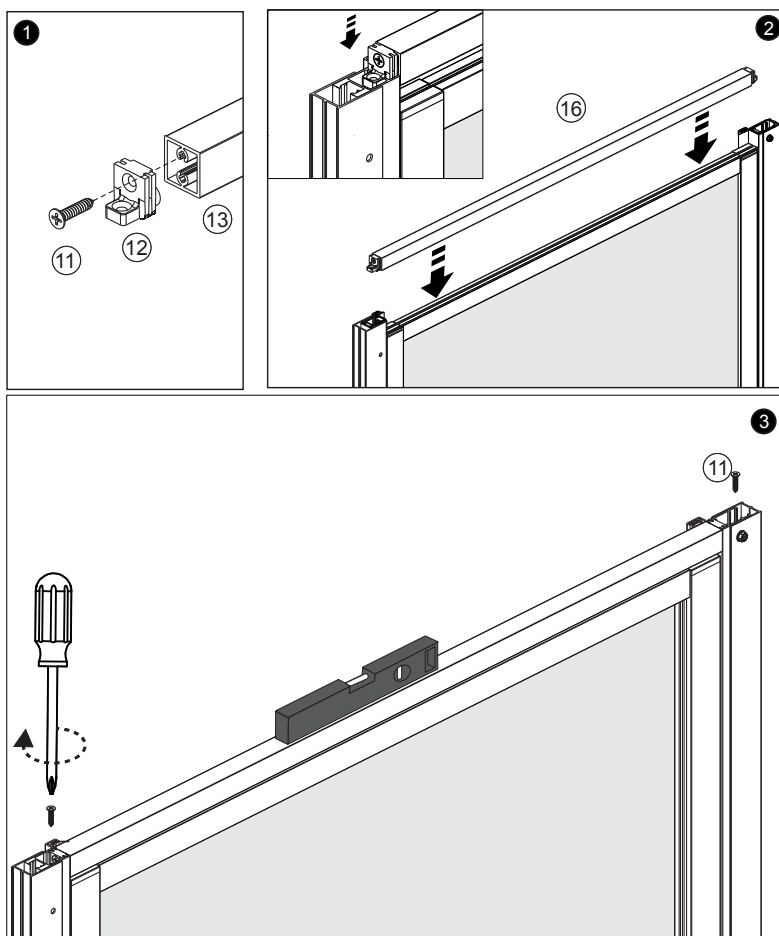
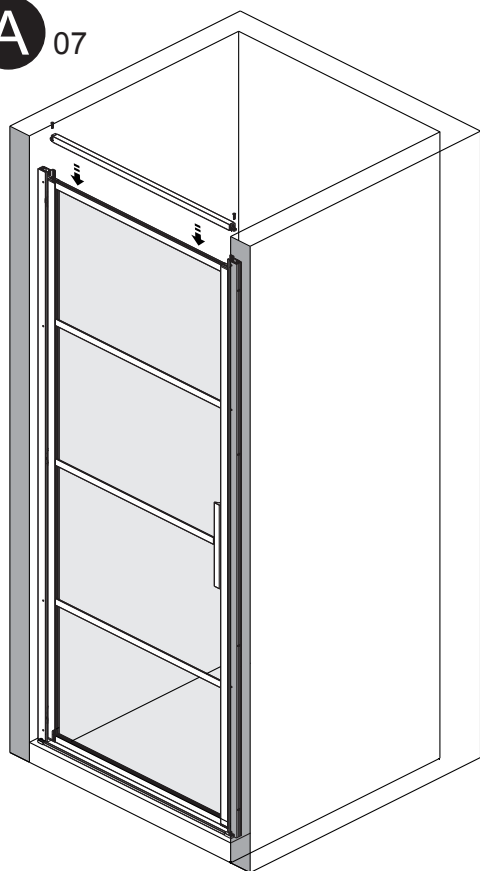

A 08

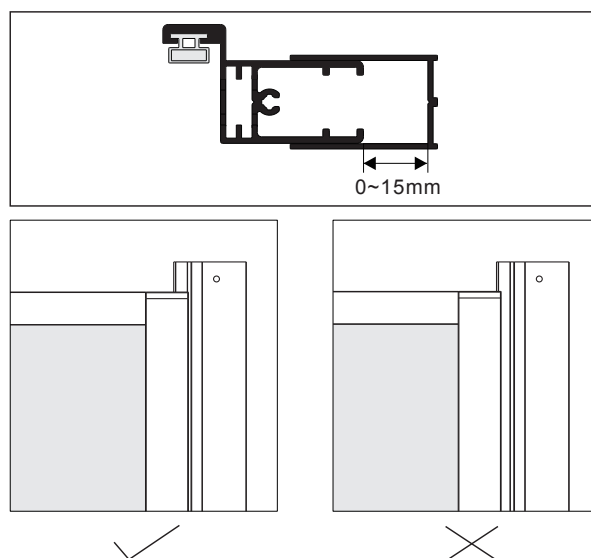
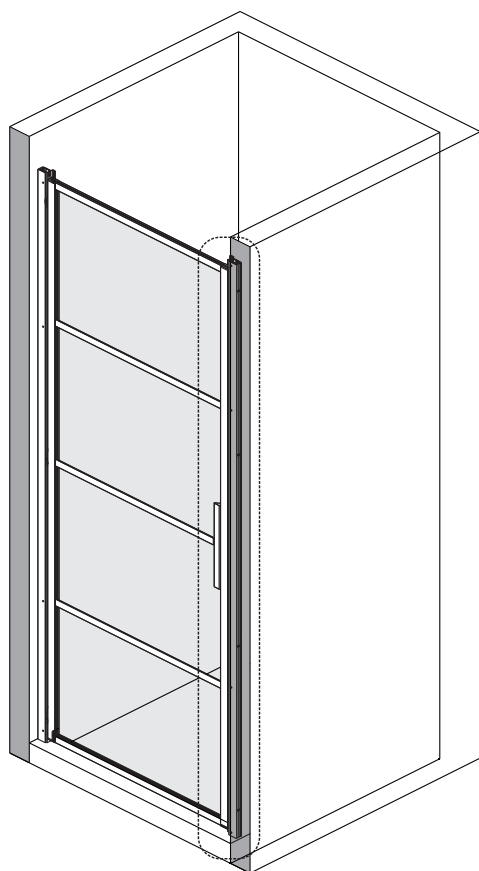



**A** 09

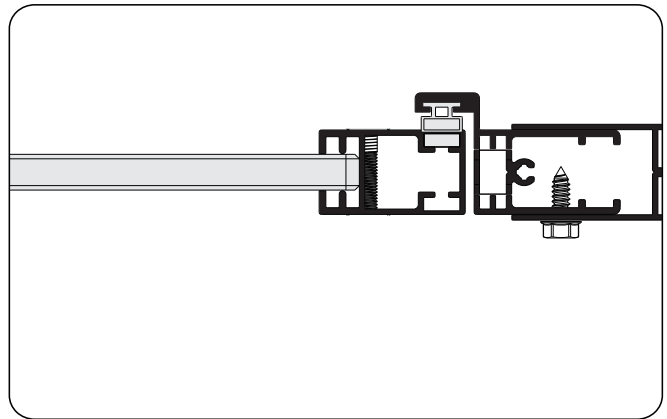
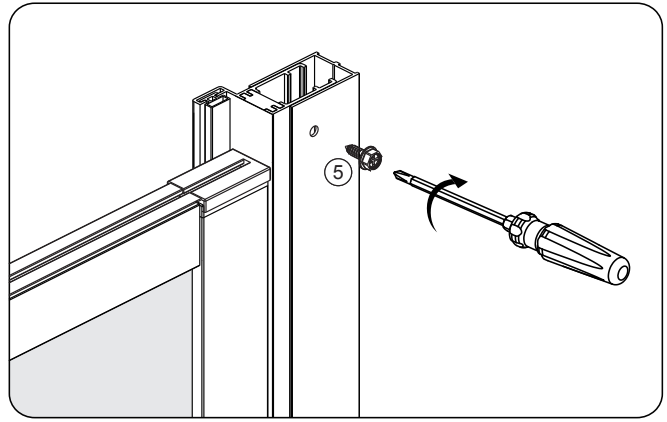
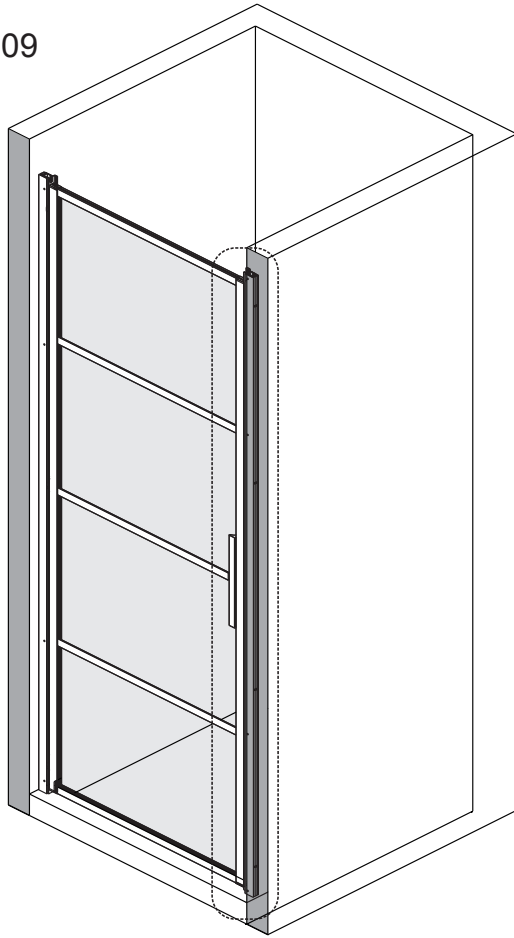

**A** 10

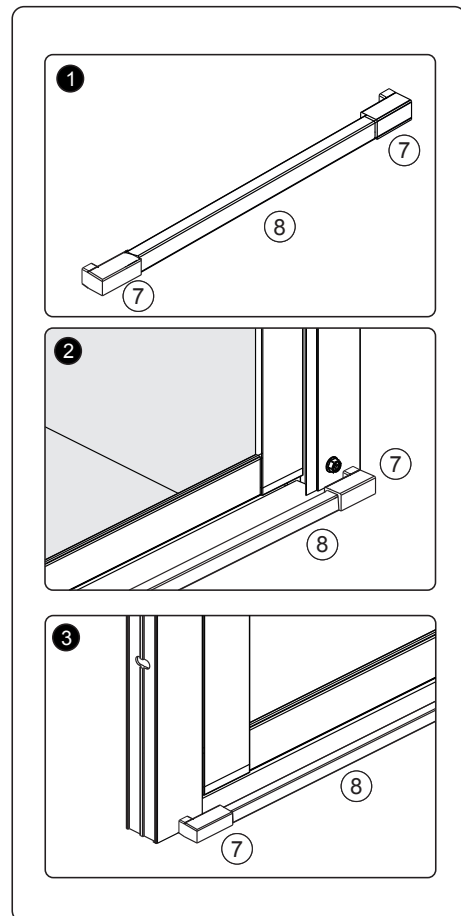
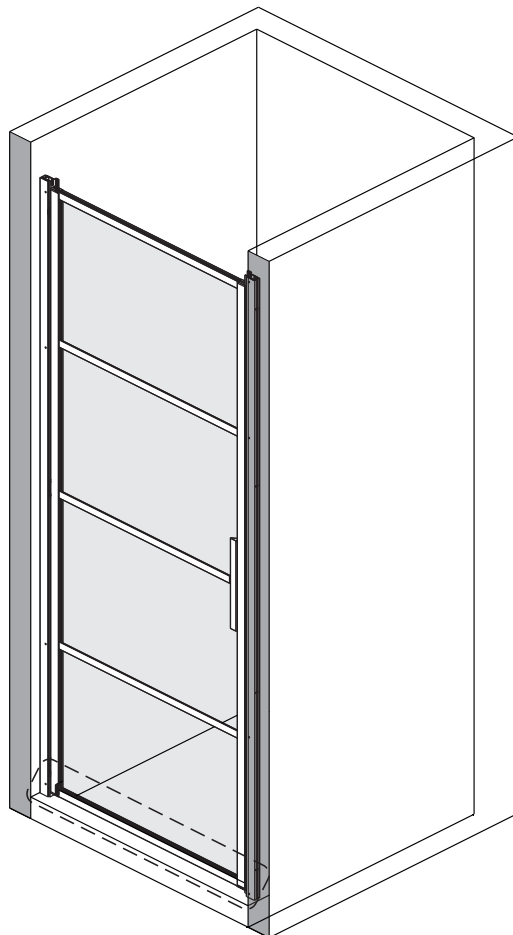

**A** 11

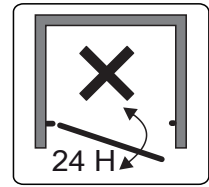
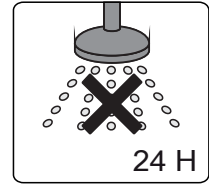
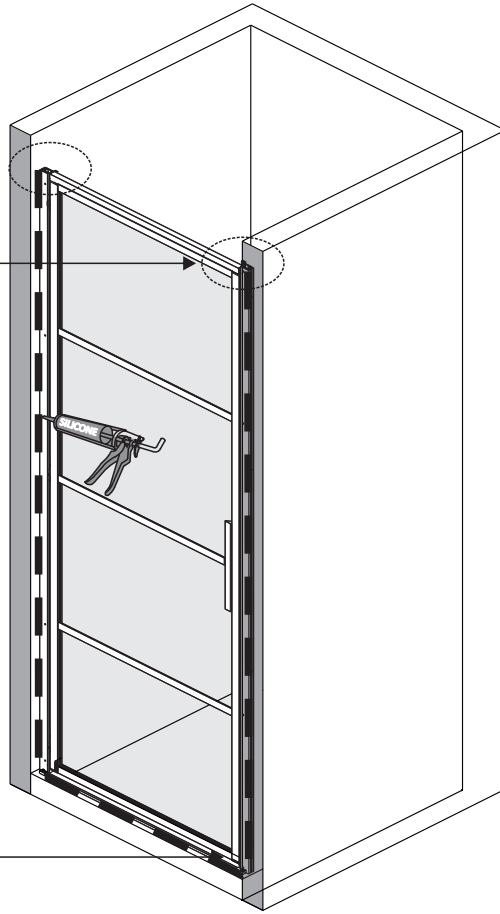
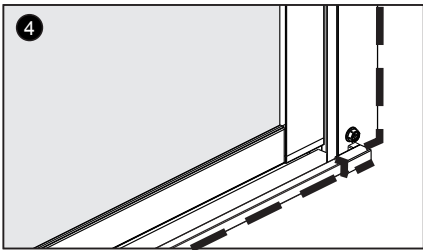
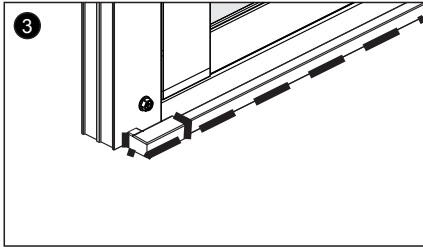
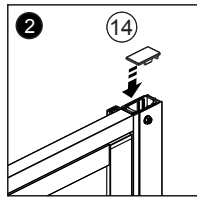
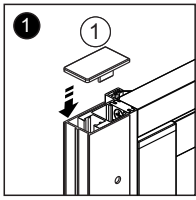

**B** 01

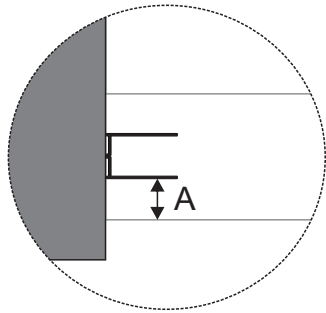
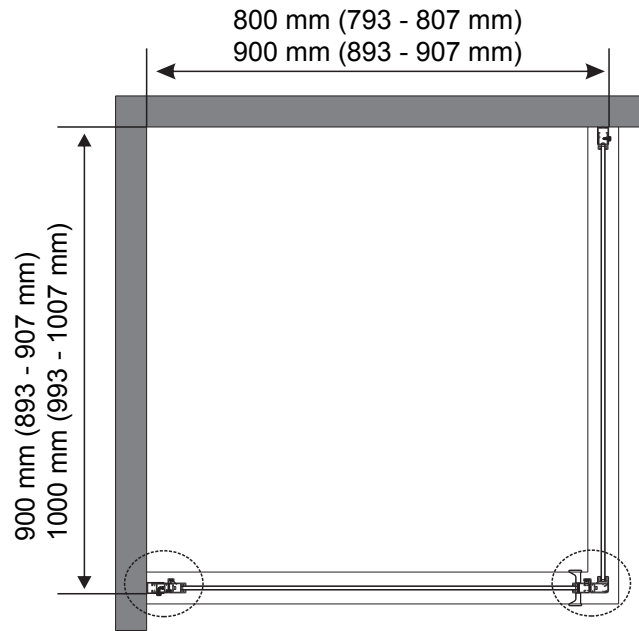

$A = B + 1$

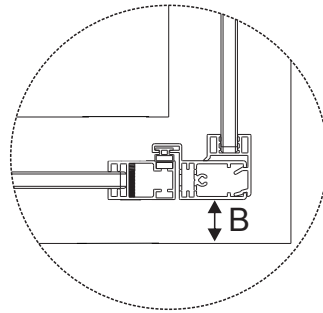

**B** 02

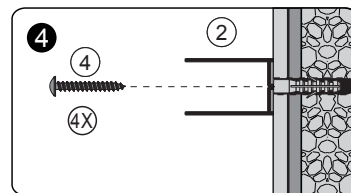
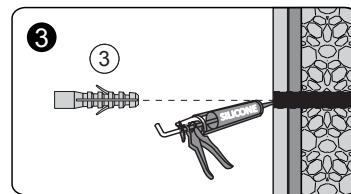
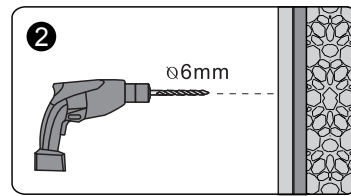
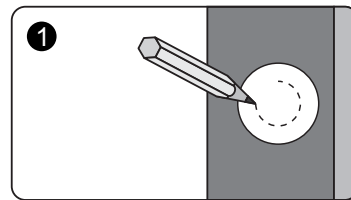
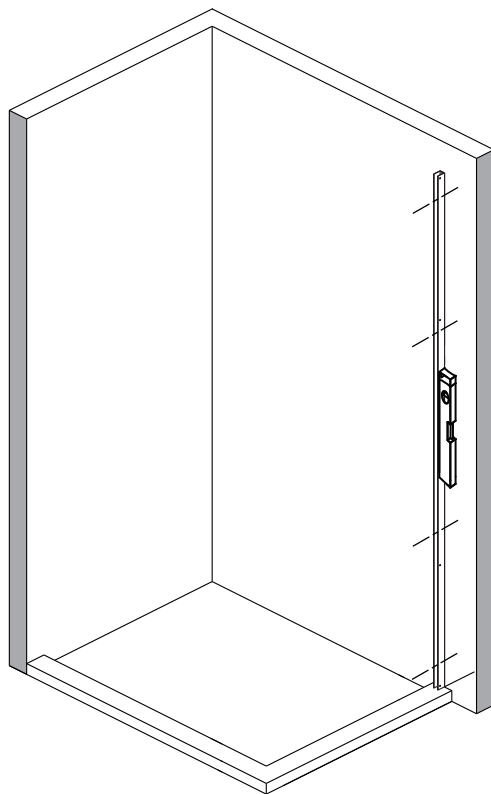

**B**<sub>03</sub>

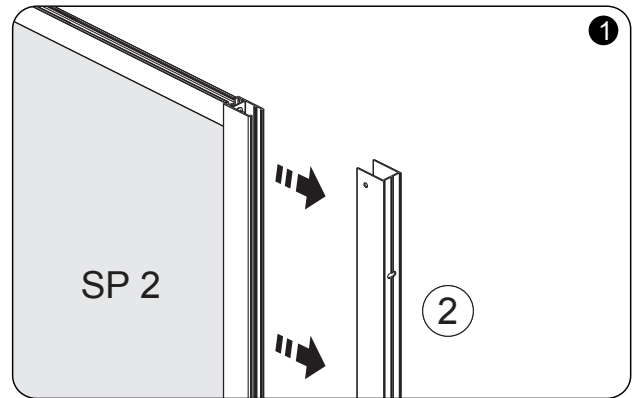
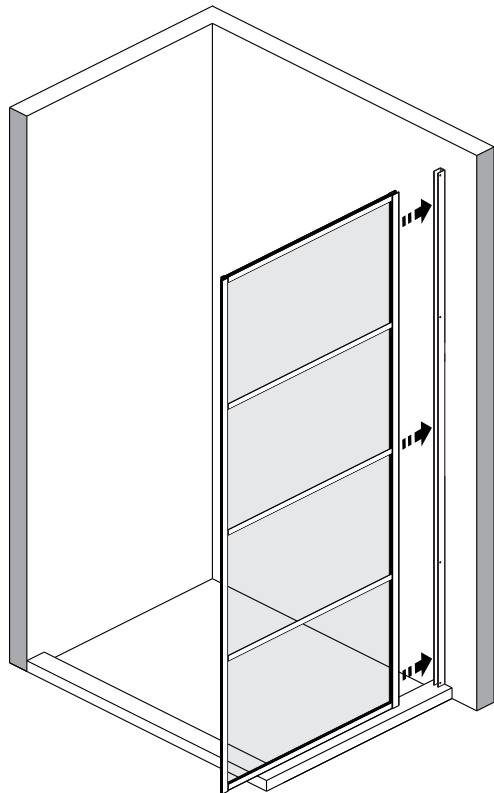

**B**<sub>04</sub>

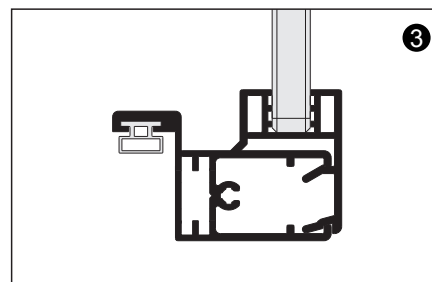
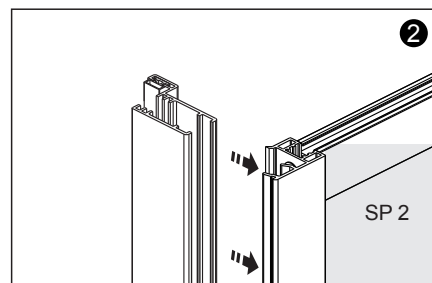
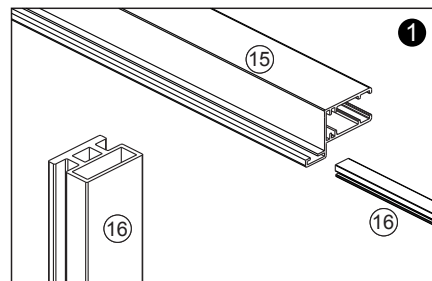
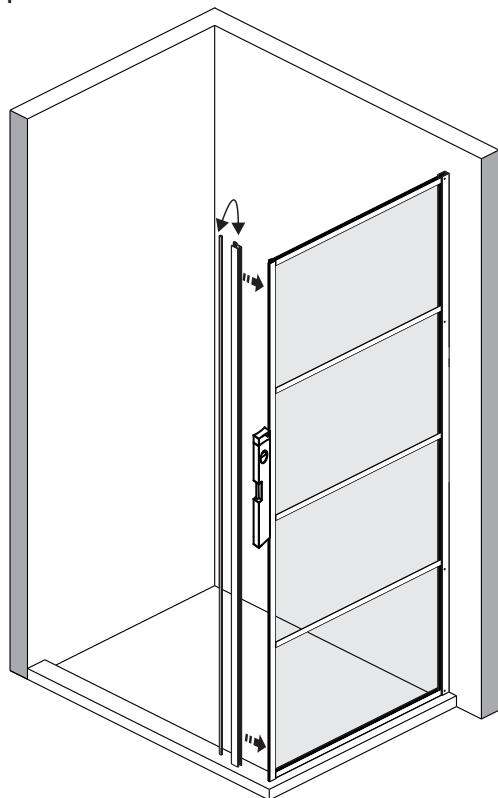

**B** 05

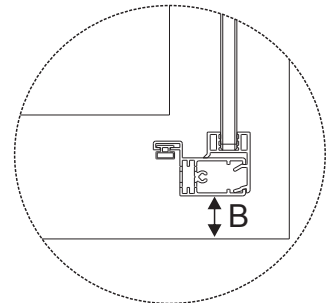
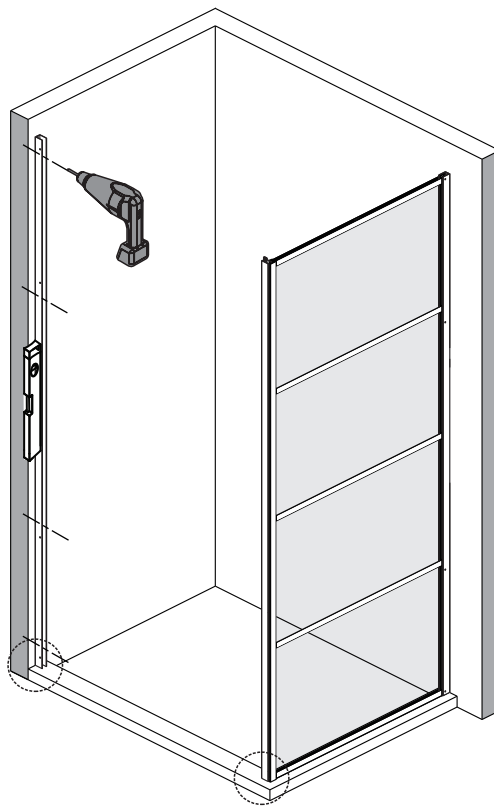
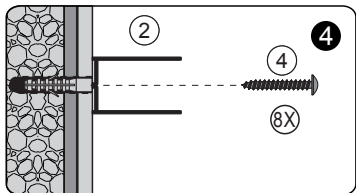
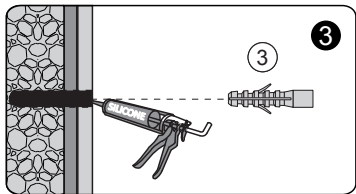
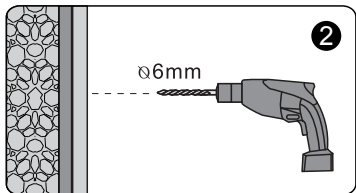
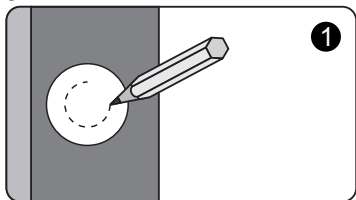

$$A = B + 1$$

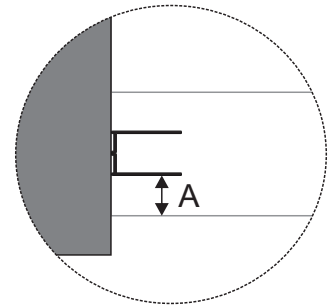

**B** 06

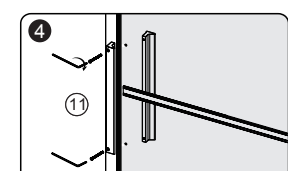
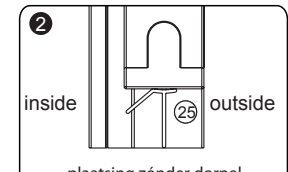
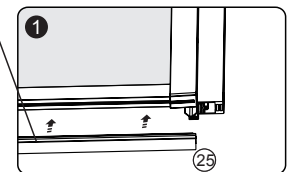
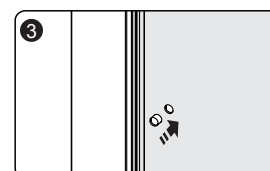
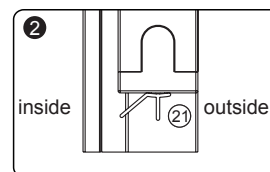
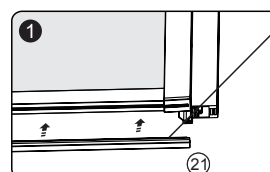
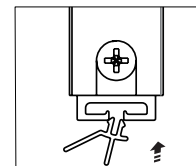
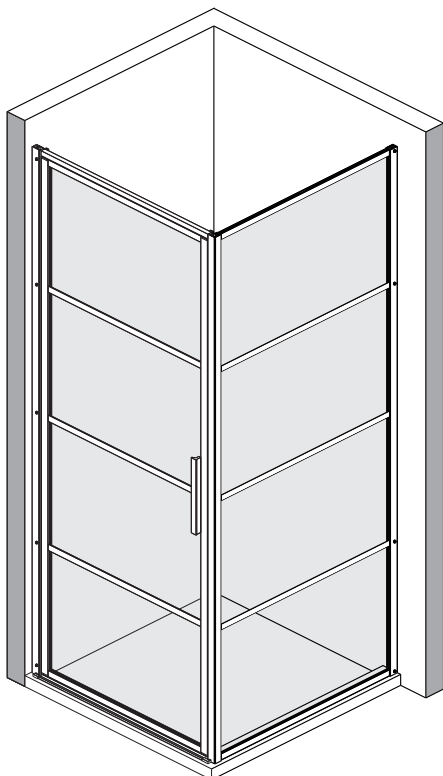

of  
ou  
or

plaatsing zónder dorpel  
placement sans seuil  
mounting without threshold

**B** 07

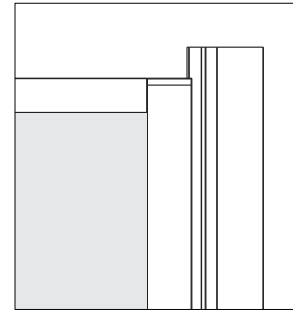
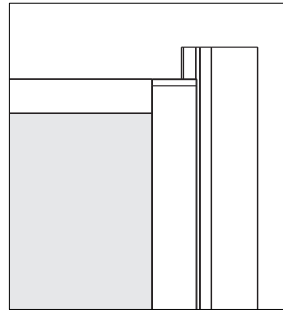
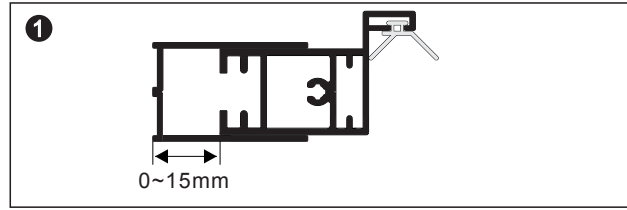
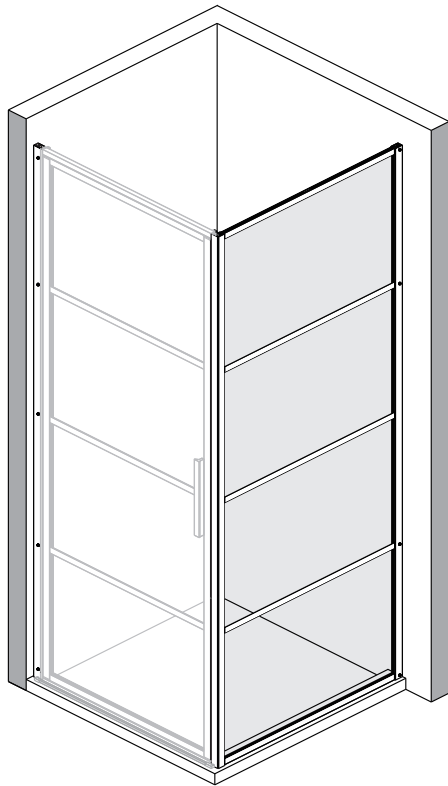

**B** 08

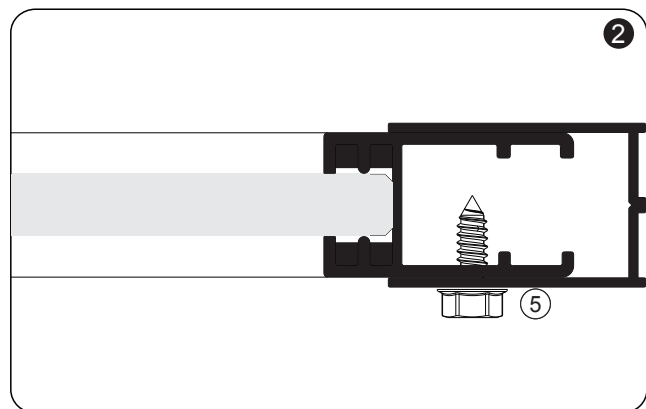
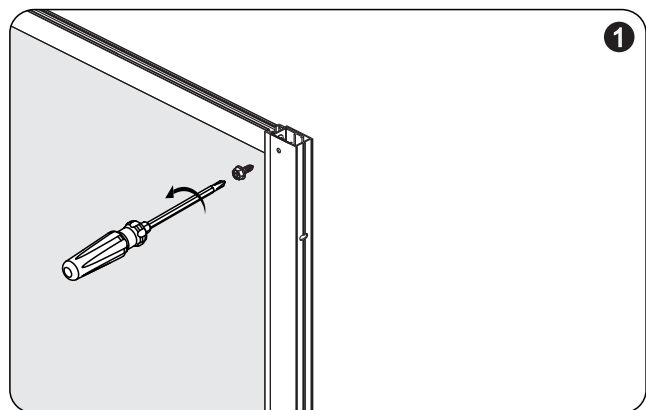
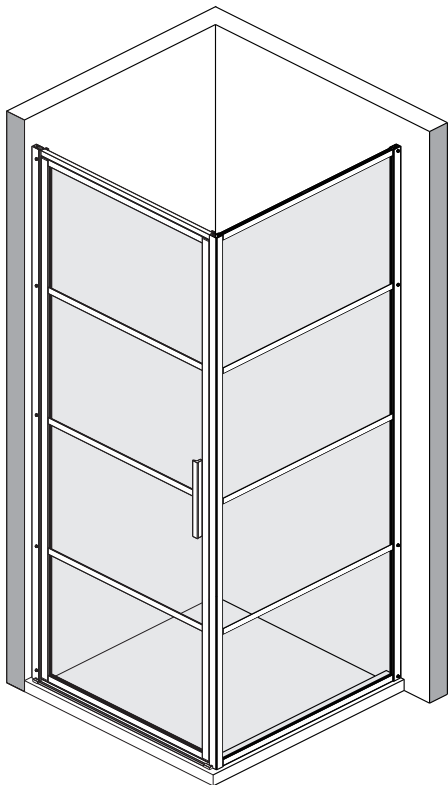

**B** 09

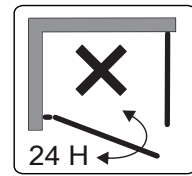
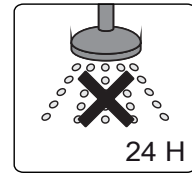
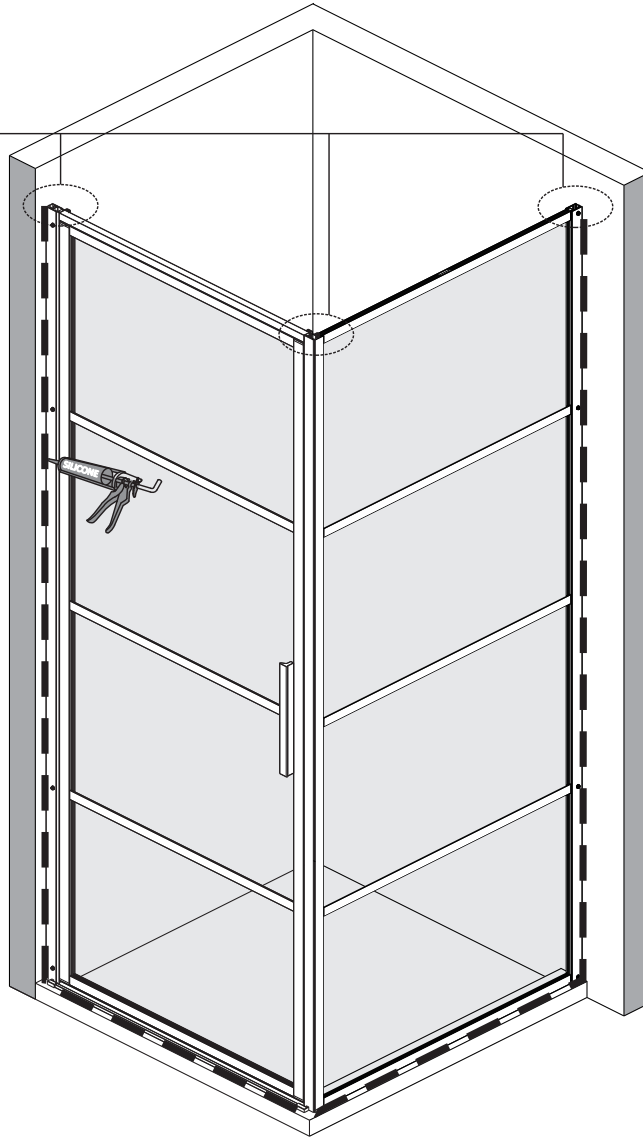
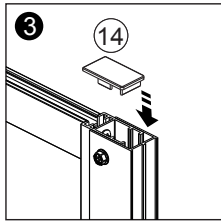
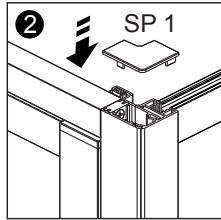
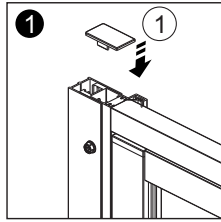

**NL** Voor de reiniging dient u een PH neutraal reinigingsmiddel of de aanbevolen Sealskin douchereiniger te gebruiken. Geen verdunner, alkalische, zuur, chloor of schurende middelen gebruiken.



**GB** For cleaning use a pH-neutral cleaning agent or the special cleaner recommended by us. Not to use are solvents, as well as alkaline, solvent -, acid- and chloric or scrubbing agents.

**FR** Pour nettoyer veuillez utiliser s'il vous plaît un produit de nettoyage avec PH neutre ou le produit spéciale recommandé par nous. N'utilisez pas des solvants, ainsi qu'alcalins, acides ou produits avec du clore ou agressif.

**DE** Zur Reinigung benutzen Sie ein PH-neutrales Reinigungsmittel oder den von uns empfohlenen Spezialreiniger. Verwenden Sie keine scheuernden, alkalischen, säure- oder chlorhaltigen Reinigungsmittel sowie Oxidations- und Lösungsmittel.

**PL** Do mycia i pielęgnacji proszę używać środków czyszczących o odczynie PH obojętnym lub polecany przez nas specjalny preparat. Nie należy stosować rozpuszczalników, jak również preparatów alkalicznych, kwaśnych, zawierających chlor lub posiadających w aściwości ściernie.



|   |  |   |
|---|--|---|
|  <p>Nr. VLS.17.004</p>   | <p>Prestatieverklaring (DOP)<br/>         Declaration Of Performance (DOP)<br/>         Leistungserklärung (DOP)<br/>         Déclaration de Performance (DOP)<br/>         Declaración de Prestaciones (DOP)<br/>         Deklaracja właściwości użytkowych (DOP)</p> |    |
| <p>1. Product types: / Produkttypen: / Produit type: / Producto tipo: / Producttype: / Typu wyrobu:</p>   |  |   |
| <p>Sealskin Soho: KB01, KB17, KB18, KB19, KB20, KBA3</p>  |  |   |
| <p>2. Personal hygiene (PH) / Persönliche Hygiene (PH) / L'hygiène personnelle (PH) / Higiene personal (PH) / Persoonlijke hygiëne (PH) / Higiene osobista (PH) /</p>   |  |   |
| <p>3. <b>Van Loon / Sealskin B.V.</b><br/>         Tuinstraat 26<br/>         5144 NT Waalwijk<br/>         Postbus 6, 5140 AA Waalwijk<br/>         Nederland</p>  |  |   |
| <p>4. n.a.</p>  |  |   |
| <p>5. System 4 / System 4 / Système 4 / Sistema 4 / Systeem 4 / System 4 /</p>  |  |   |
| <p>6. Determination of product type and factory production control by the manufacturer<br/>         Feststellung des Produkttyps und werkseigene Produktionskontrolle durch den Hersteller<br/>         Détermination du produit type et contrôle de la production effectuée par le fabricant<br/>         Determinación del producto tipo y control de la producción en fábrica efectuada por el fabricante<br/>         De bepaling van het producttype en de productiecontrole in de fabriek wordt door de fabrikant uitgevoerd<br/>         Producent przeprowadza: ustalenie typu wyrobu i zakładową kontrolę produkcji</p>  |  |   |
| <p>7. n.a.</p>  |  |   |
| <p>8. Essential characteristics<br/>         Wesentliche Merkmale<br/>         Caractéristiques essentielles<br/>         Características esenciales<br/>         Essentiële kenmerken<br/>         Zasadnicze charakterystyki</p>  | <p>Performance<br/>         Leistung<br/>         Performances<br/>         Prestaciones<br/>         Prestaties<br/>         Właściwości</p>  | <p>Harmonized technical specification<br/>         Harmonisierte technische Spezifikation<br/>         Spécifications techniques harmonisées<br/>         Especificaciones técnicas armonizadas<br/>         Geharmoniseerde techinsche specificaties<br/>         Zharmonizowana specyfikacja techniczna</p> |
| <p>CA</p>   | <p>Pass</p>  | <p>EN 14428:2015</p>  |
| <p>IR</p>   | <p>Pass</p>  |   |
| <p>DA</p>   | <p>NPD</p>   |   |
| <p>9. The performance of the product identified in points 1 and 2 is in conformity with the declared performance in point 9. This declaration of performance is issued under the sole responsibility of the manufacturer identified in point 4. Signed for and on behalf of the manufacturer by:<br/>         Die Leistung des Produkts gemäß den Nummern 1 und 2 entspricht der erklärten Leistung nach Nummer 9. Verantwortlich für die Erstellung dieser Leistungserklärung ist allein der Hersteller gemäß Nummer 4. Unterzeichnet für den Hersteller und im Namen des Herstellers von:<br/>         Les performances du produit identifié aux points 1 et 2 sont conformes aux performances déclarées indiquées au point 9. La présente déclaration des performances est établie sous la seule responsabilité du fabricant identifié au point 4. Signé pour le fabricant et en son nom par:<br/>         Las prestaciones del producto identificado en los puntos 1 y 2 son conformes con las prestaciones declaradas en el punto 9. La presente declaración de prestaciones se emite bajo la sola responsabilidad del fabricante identificado en el punto 4. Firmado por y en nombre del fabricante por:<br/>         De prestaties van het in de punten 1 en 2 omschreven product zijn conform de in punt 9 aangegeven prestaties. Deze prestatieverklaring wordt verstrekt onder de exclusieve verantwoordelijkheid van de in punt 4 vermelde fabrikant:<br/>         Ondertekend voor en namens de fabrikant door:<br/>         Właściwości użytkowe wyrobu określone w pkt 1 i 2 są zgodne z właściwościami użytkowymi deklarowanymi w pkt 9.<br/>         Niniejsza deklaracja właściwości</p> |  |   |
| <p>J. Elsen</p>   |  |    |
| <p>Legal representative / Gesetzlicher Vertreter / Représentant légal /<br/>         Representante legal / Wettelijke vertegenwoordiger / Przedstawiciele prawnych</p>  |  |   |
| <p>Waalwijk, 30-10-2017</p>   |  |   |

# SOHO

KB19  
KB20  
KB01

Garantiebewijs  
Warranty card  
Garantieschein  
Carte de garantie  
Certificato di garanzia  
Certificado de garantía

This Sealskin product has a warranty period of 5 years. Normal wear and tear on components such as gaskets are excluded from this warranty.

Wholesale dealer: .....

Adress: .....

Phone: .....

Fax: .....

Installer: .....

Adress: .....

Phone: .....

Fax: .....



**NL** De producent houdt zich het recht voor, ten alle tijde zonder tegenbericht, veranderingen door te voeren.  
**GB** The producer reserves the right to modify the product at any time without prior notice.  
**DE** Der Produzent behält sich jederzeit das Recht, ohne Vorbescheid Abänderungen vorzunehmen.  
**FR** Le producteur se réserve le droit de modifier le produit sans aucun préavis.  
**SV** Tillverkaren förbehåller sig all rätt att produktförändra  
**PL** Producent rezerwuje sobie prawo modyfikacji produktu bez wcześniejszego powiadomienia.

**sealskin** ®