

# INSTALLATION INSTRUCTIONS

**SW422/SW2687**

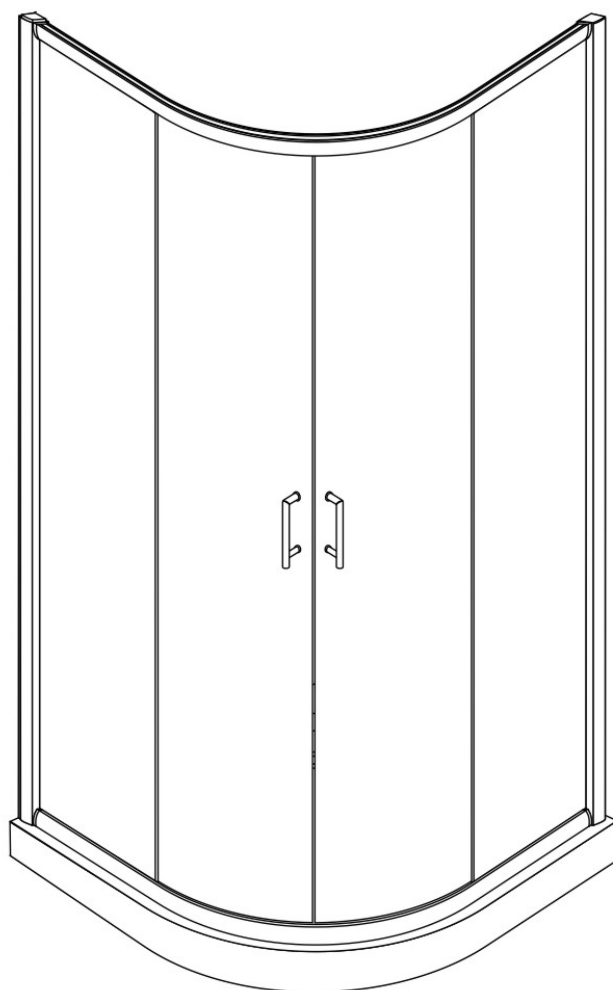

Size: 800x800x1950mm  
900x900x1950mm

## ◆ General Information

Please inspect the product immediately upon receipt for transit damage, missing packs/parts or manufacturing fault. Damage reported later cannot be accepted. Please handle the product with care avoiding knocks and shock loading to all sides and edges of the glass.

### Notes: Safety glass can not be re-worked.

Please read these instructions carefully before start of installation.

Special care should be taken when drilling walls to avoid hidden pipes or electrical cables.

Note: This product is heavy and may require two people to install.

## Aftercare instructions

After use, your shower should be cleaned with soap and water. This is particularly important in hard water districts where insoluble lime salts may be deposited and allowed to build up.

Cleaners of a gritty or abrasive nature should not be used. Care should be taken to avoid contact with strong chemicals such as organic solvents and strippers.

Glass cleaners can be used but with caution, if in doubt contact the manufacturer of the cleaner in question.

Please keep these instructions for aftercare and customer service details.

---



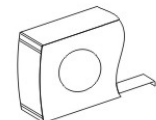
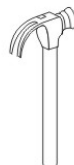
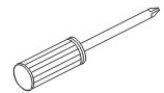
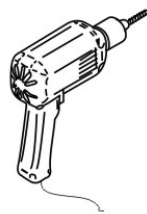
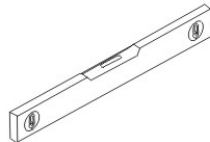
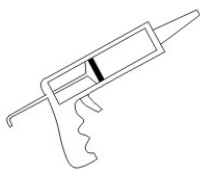





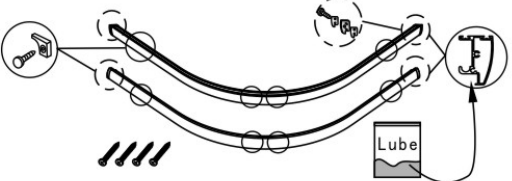

## Tools Required

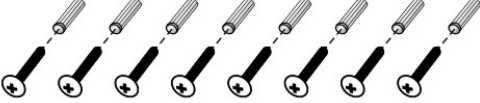

**This product is heavy and may require two people to install.**

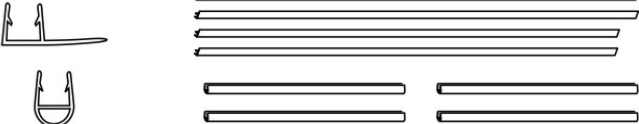

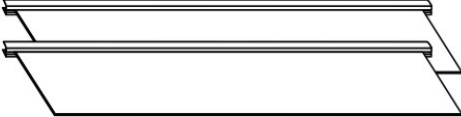
# ◆ Box Contents:

<p>[1] 2xHorizontal Rails. 4xRound Screws M4x35. 1xLube.</p>	<p>➔</p>	
<p>[2] 1xInstallation Instruction.</p>	<p>➔</p>	
<p>[3] 2xHandle Sets.</p>	<p>➔</p>	
<p>[4] 4xProfile Covers.</p>	<p>➔</p>	
<p>[5] 4xBumper Blocks. 4xScrews M4x12.</p>	<p>➔</p>	
<p>[6] 8xWall Plugs. 8xFlat Screws M4x35.</p>	<p>➔</p>	
<p>[7] 8xScrews M4x8. 8xScrew Cover Caps.</p>	<p>➔</p>	
<p>[8] 4xWater Deflectors. 4xDeflectors.</p>	<p>➔</p>	
<p>[9] 2xMagnetic Seals.</p>	<p>➔</p>	
<p>[10] 2xWall Posts.</p>	<p>➔</p>	
<p>[11] 2xFixed Panels.</p>	<p>➔</p>	
<p>[12] 2xDoor Panels.</p>	<p>➔</p>	

# ◆ Assembly Drawing

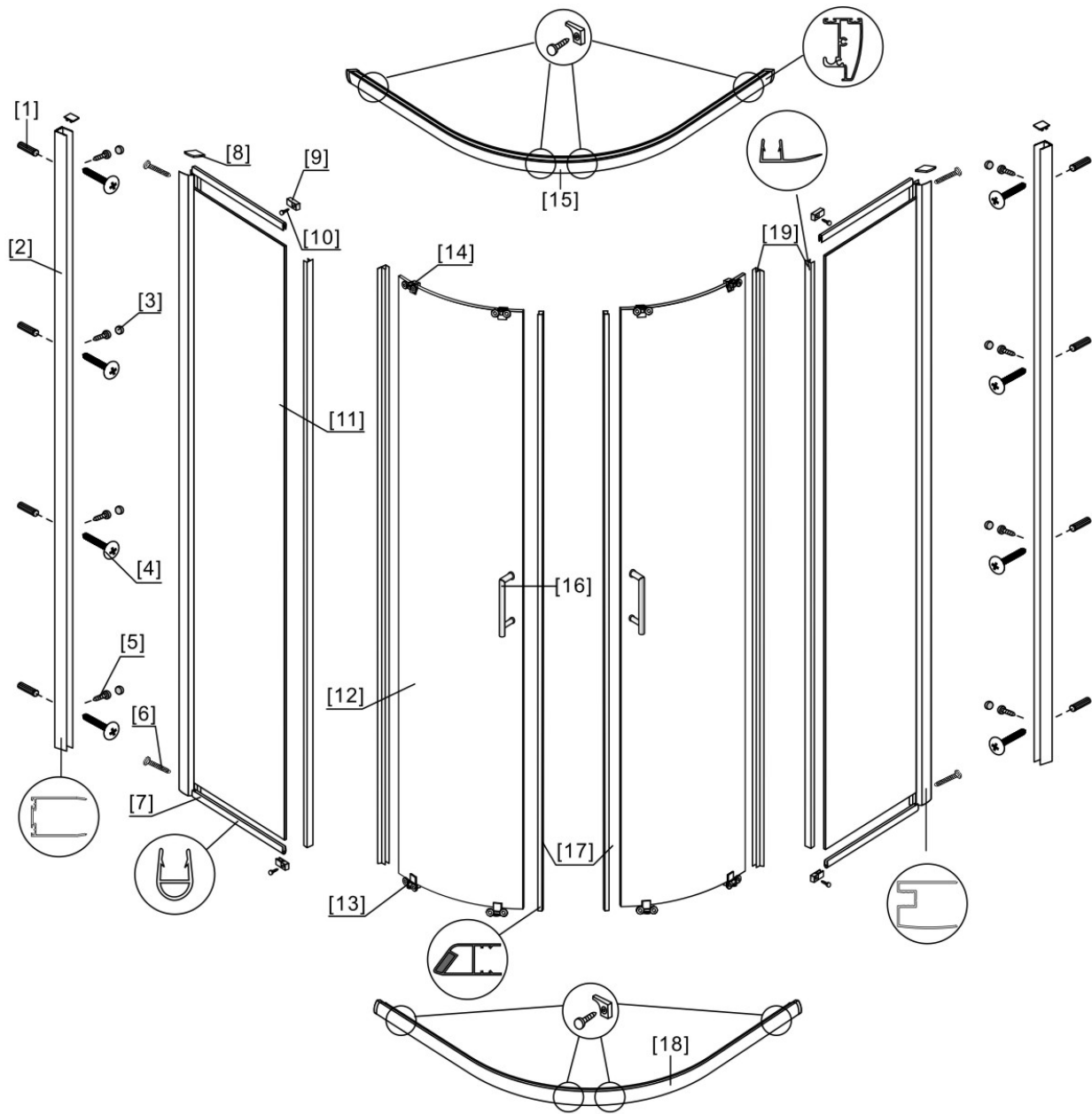

- [1] 8xWall Plugs
- [2] 2xWall Posts
- [3] 8xScrew Cover Caps
- [4] 8xFlat Screws M4x35
- [5] 8xScrews M4x8
- [6] 4xRound Screws M4x35
- [7] 4xDeflectors
- [8] 4xProfile Covers
- [9] 4xBumper Blocks

- [10] 4xScrews M4x12
- [11] 2xFixed Panels
- [12] 2xDoor Panels
- [13] 4xBottom Hooks
- [14] 4xTop Rollers
- [15] 1xTop Horizontal Rail
- [16] 2xHandle Sets
- [17] 2xMagnetic Seals
- [18] 1xBottom Horizontal Rail
- [19] 4xWater Deflectors

# ◆ Installation Steps

## Step 1

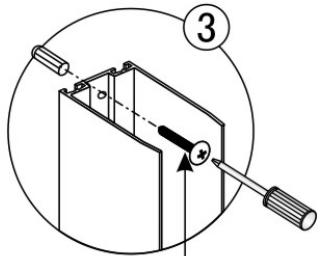
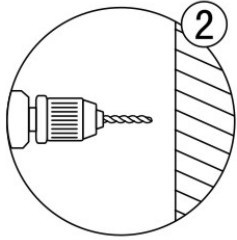
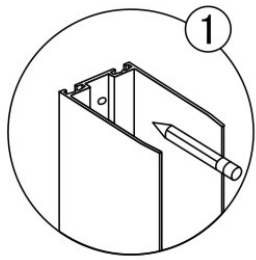

Flat Screw  
M4x35

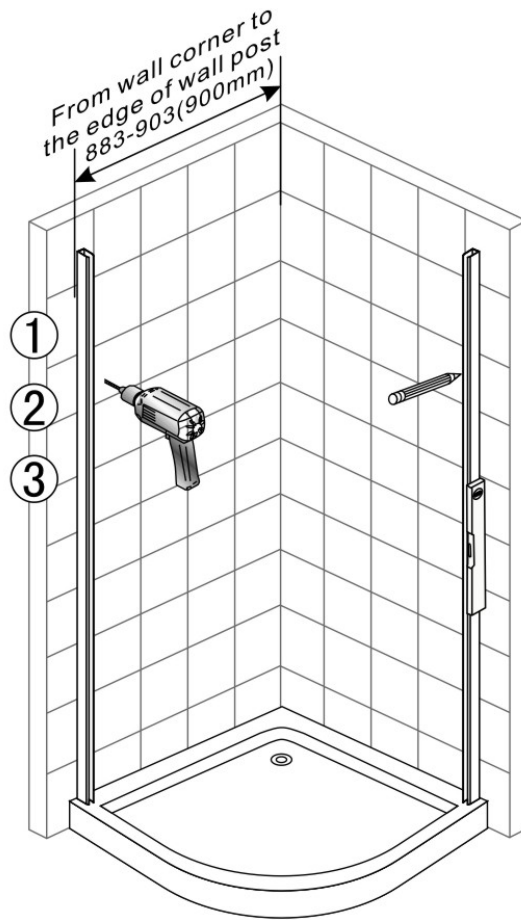

## Step 2

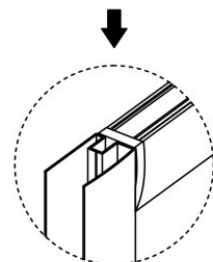
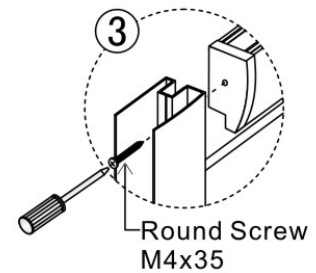
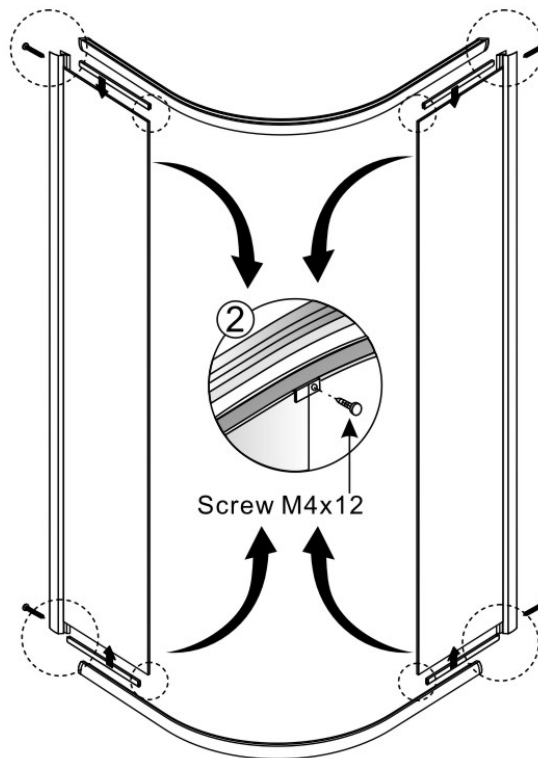
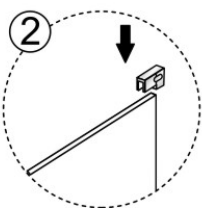
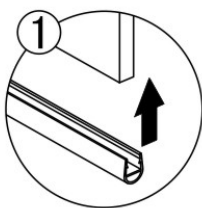

## Step 5

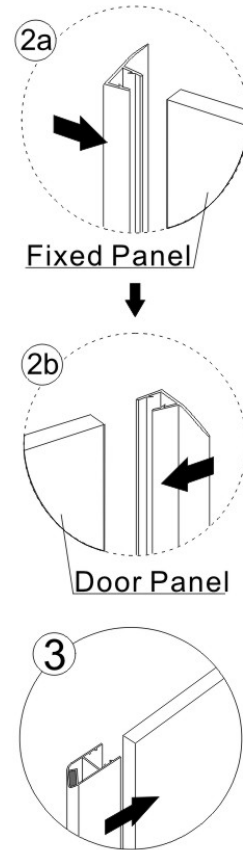
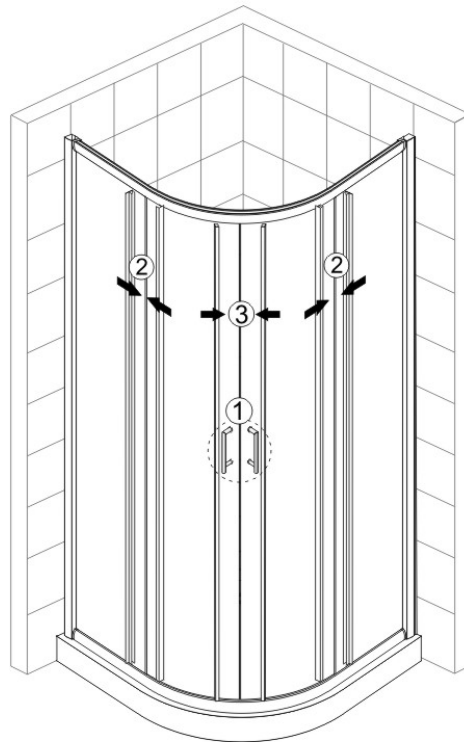
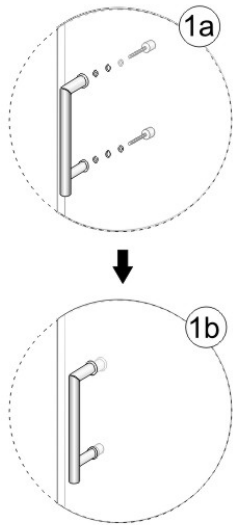

**!** Ensure wall profiles are plumb.  
Adjust enclosure to be square and level.  
Wheels should be adjusted to square the doors and ensure smooth running.

## Step 6

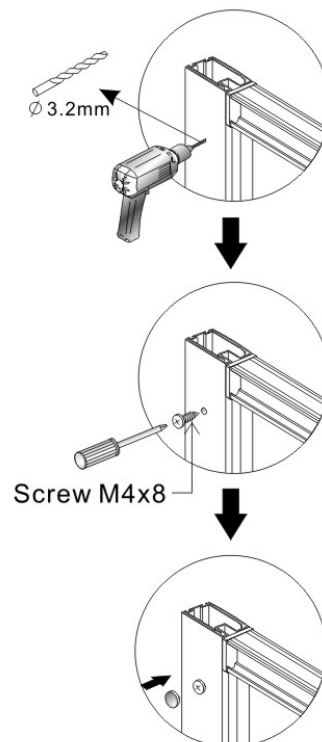
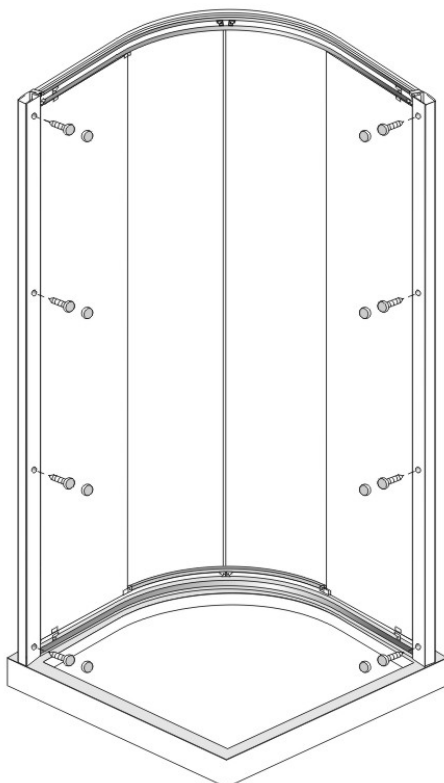

View from inside

### Step 3

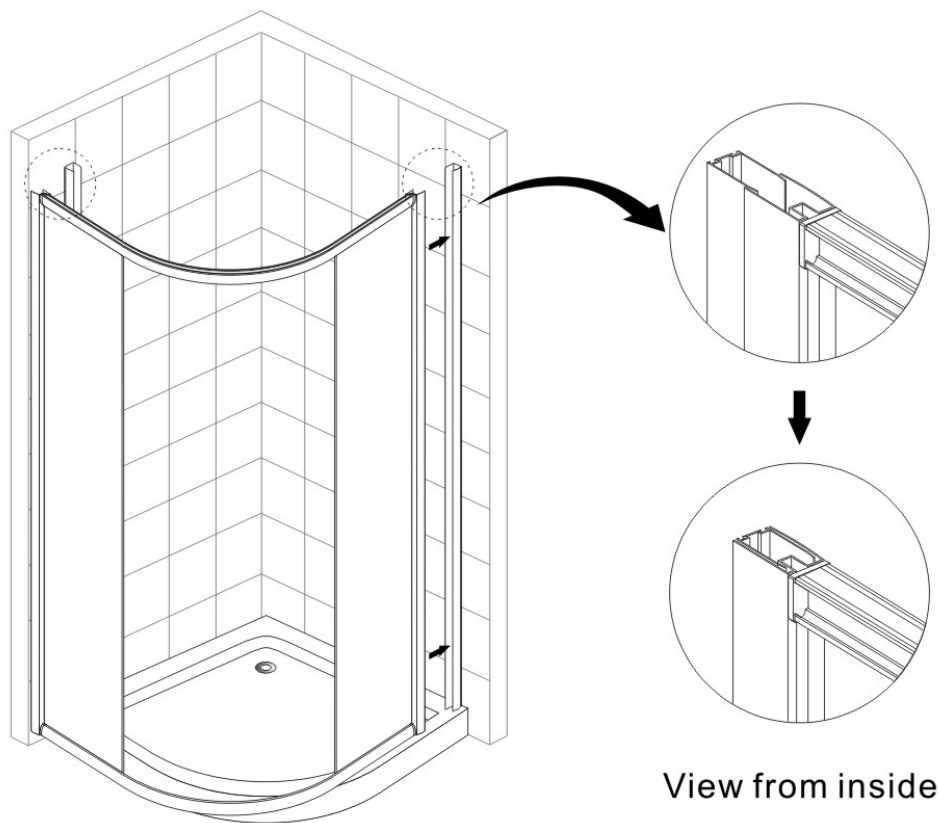

### Step 4

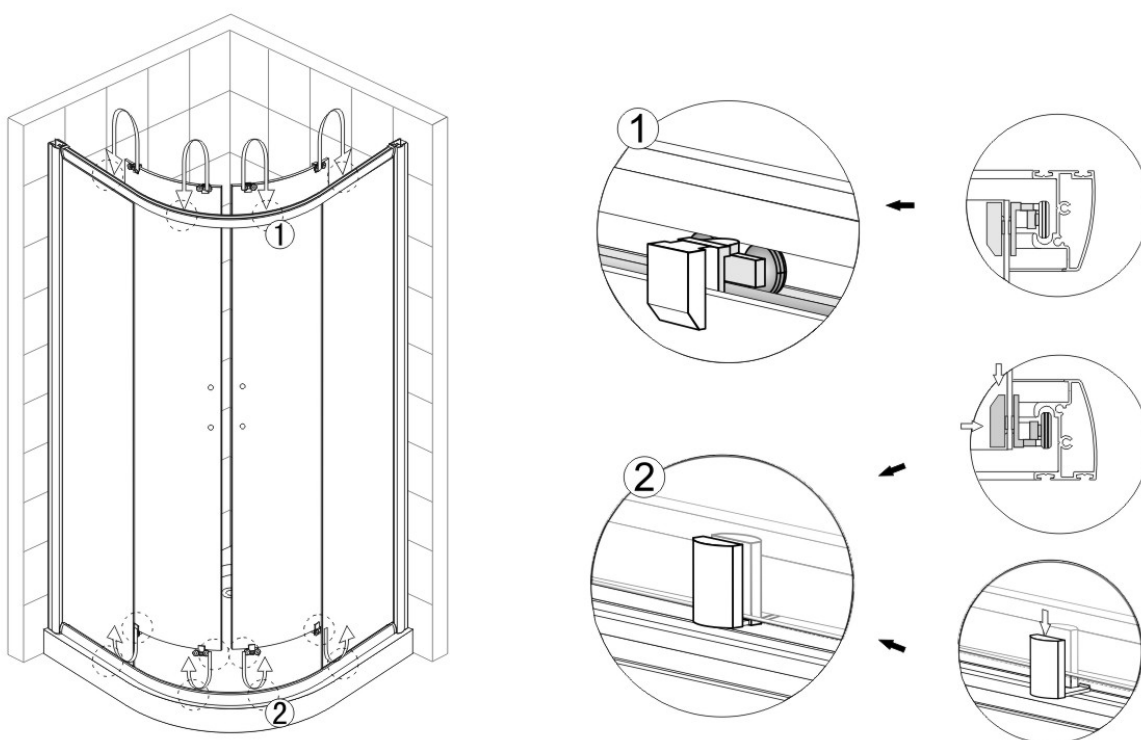

# Step 7

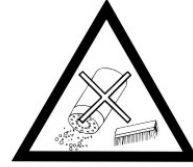
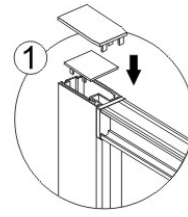
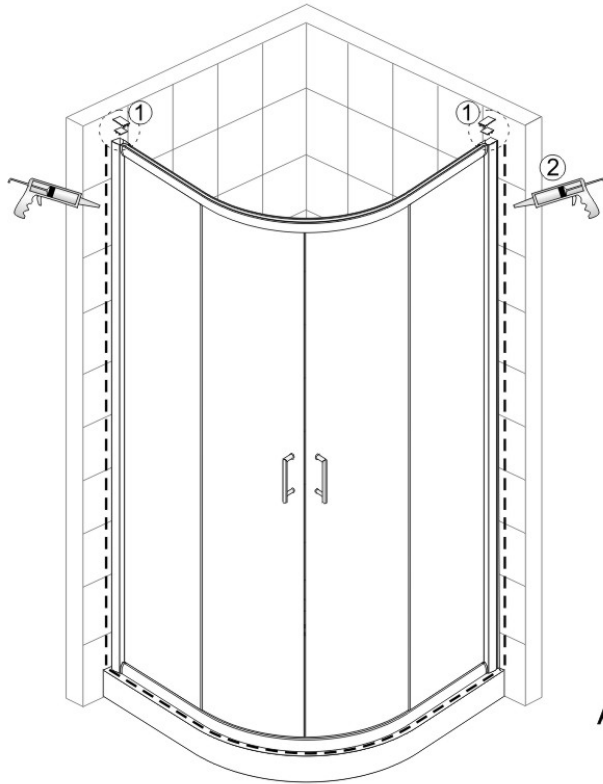

**Allow 24 hours for silicone to dry before use.**