

# SUNSHOWER DELUXE WHITE

## Installatiehandleiding

### Deel 2: Het installeren van de SUNSHOWER

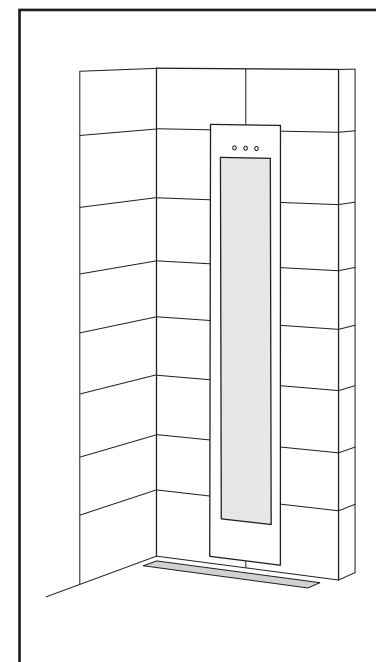

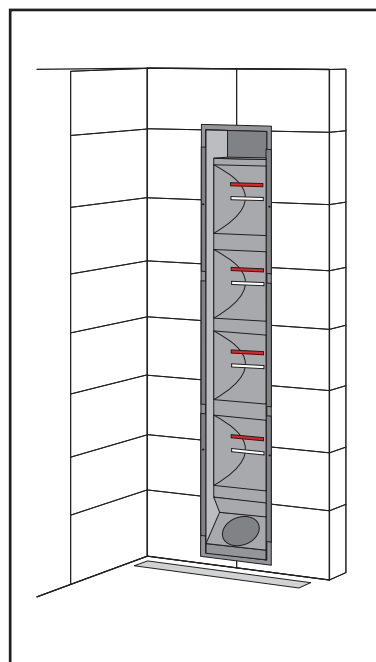
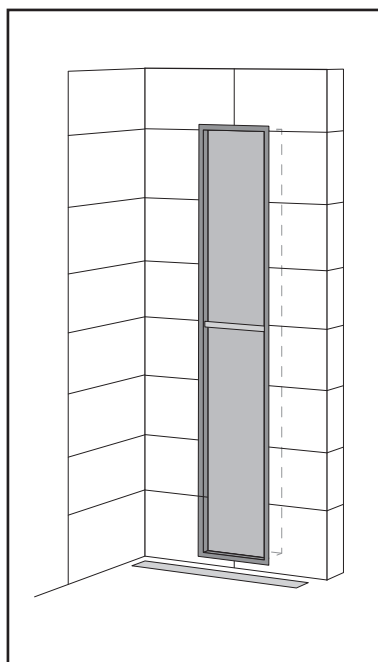

### In de doos

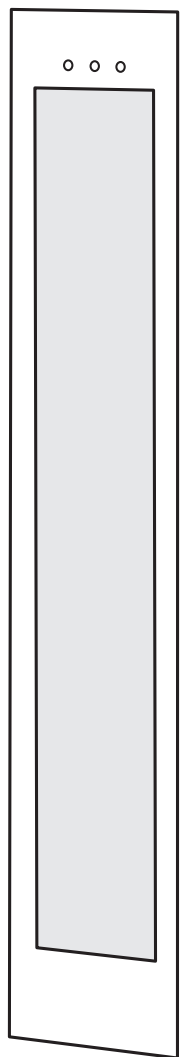

Glasplaat

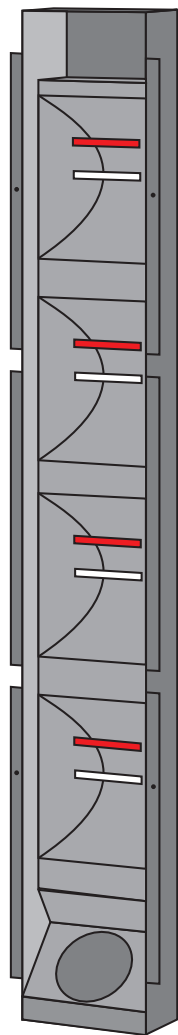

Behuizing

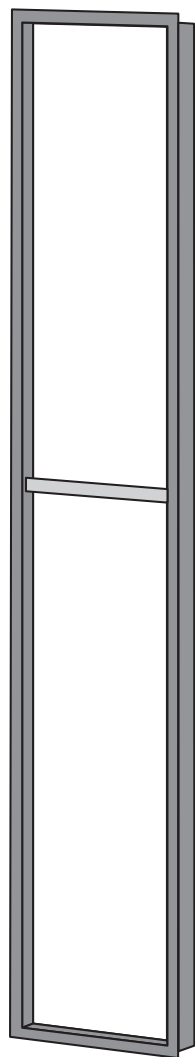

Wandframe



Mof 2x



Schetsplaat onder



Schetsplaat boven

### Niet meegeleverd

2x

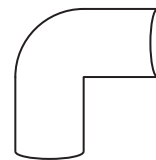

2x

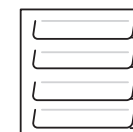

4x

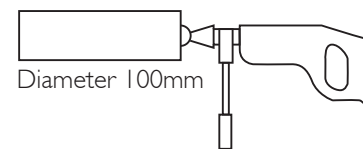
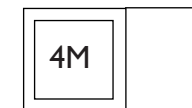
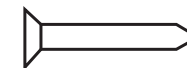

Diameter 100mm



### Meegeleverd

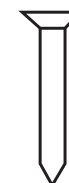

12x

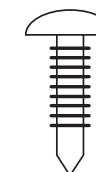

8x

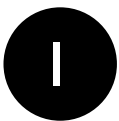

## Verwijderen dwarsbalk wandframe



SUNSHOWER

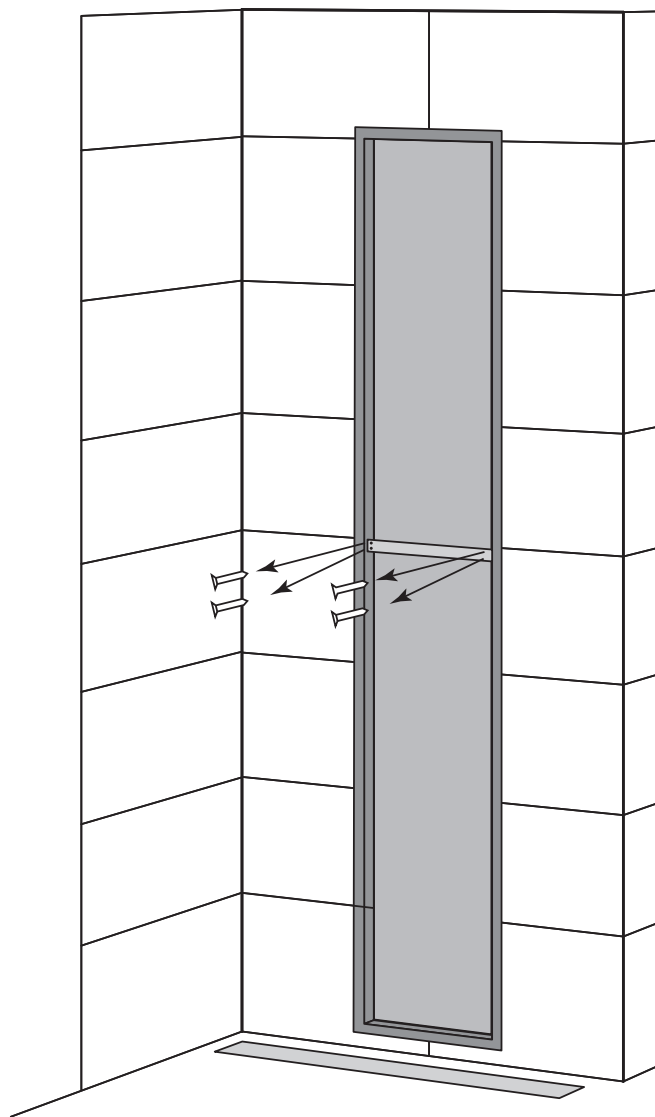

3D Voorbeeld

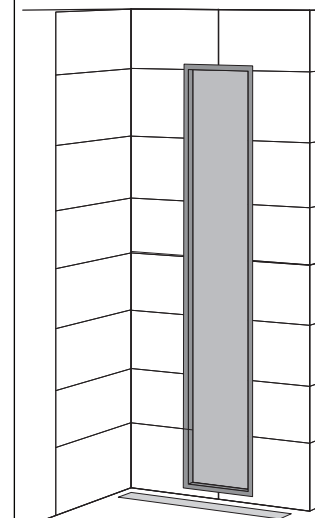

Benodigheden

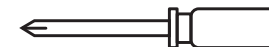

Instructies

Alvorens met deze stap te beginnen dient installatiehandleiding deel I volledig afgewerkt te zijn. Verwijder de dwarsbalk van het wandframe



SUNSHOWER

3D Voorbeeld

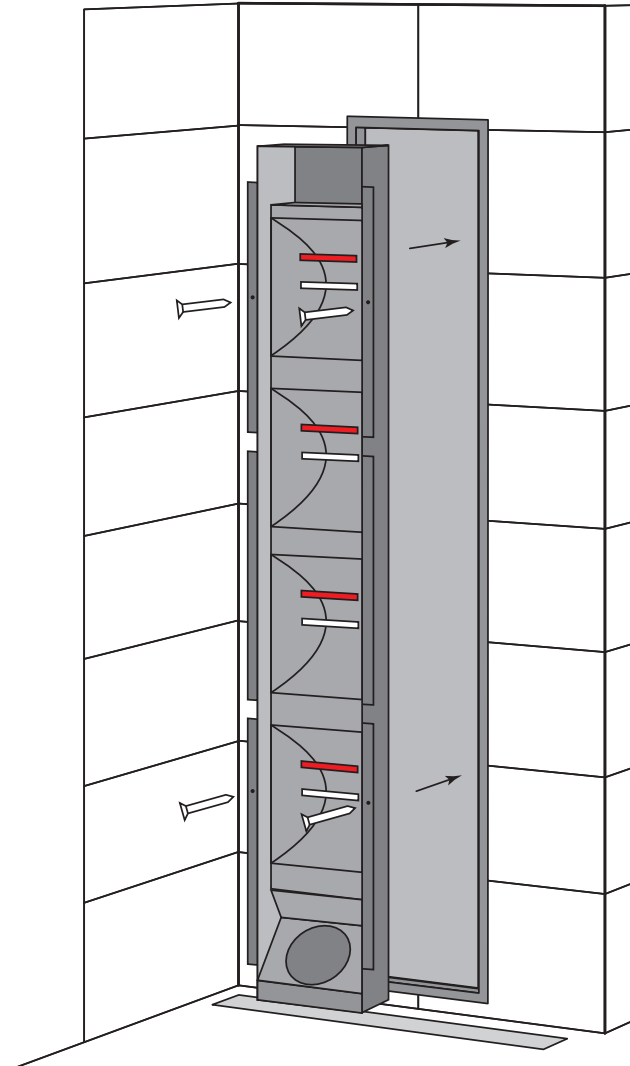

Benodigheden

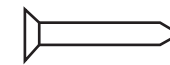

4x

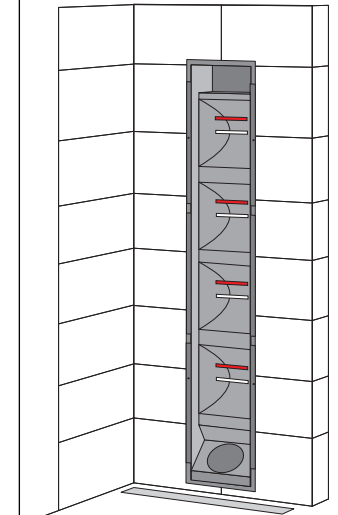
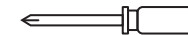

Instructies

Plaats de behuizing recht in het frame.

Plaats de schroeven op de aangegeven positie boven en onder in het frame.



SUNSHOWER

3D Voorbeeld

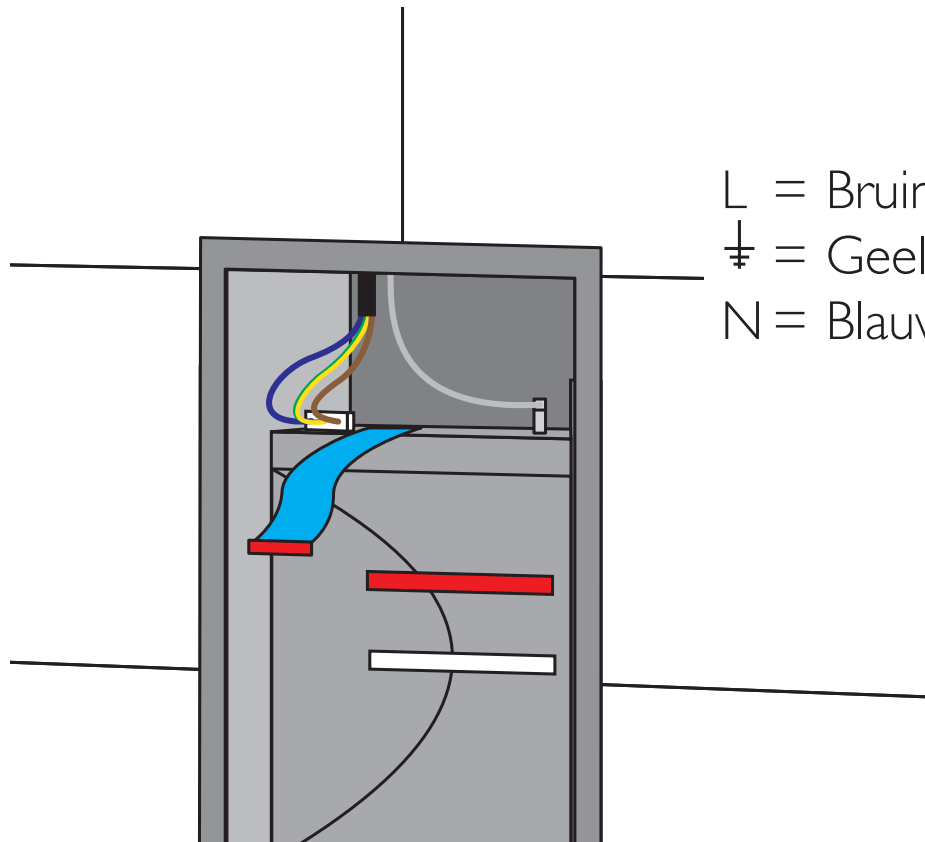
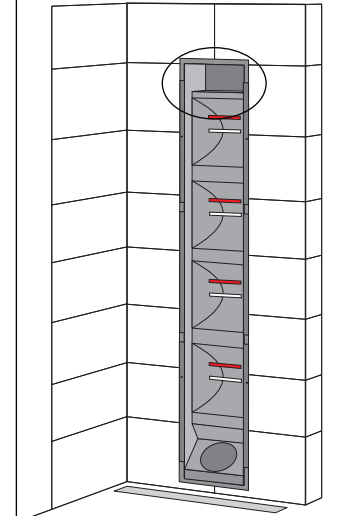

L = Bruin (live)  
 ⚡ = Geel groen (aarde)  
 N = Blauw (neutral)

#### Instructies

Sluit de elektradraden aan volgens schema. Controleer de aansluitingen op de witte kroonsteen bovenin.

Klem de potentiaal vereffeningkabel in de klem rechts bovenin.



SUNSHOWER

3D Voorbeeld

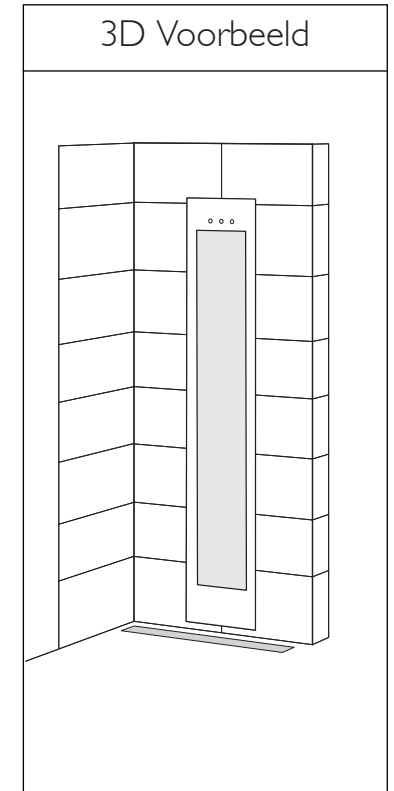
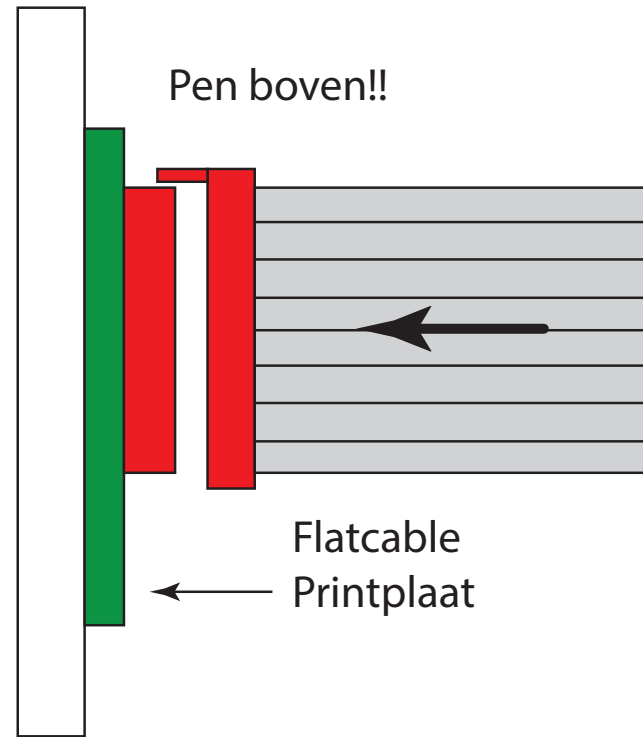
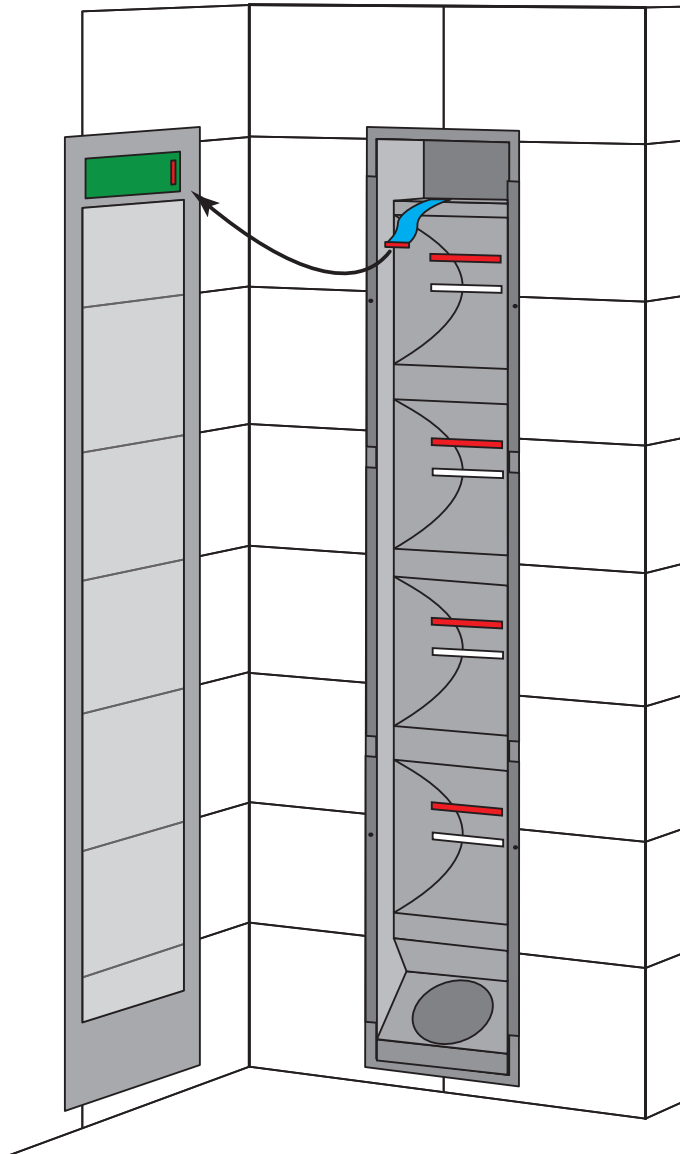

## Instructies

Let op!

Sluit de flatcable aan op de printplaat achterop de glasplaat. Het rode pennetje aan de flatcable zit boven!!



SUNSHOWER

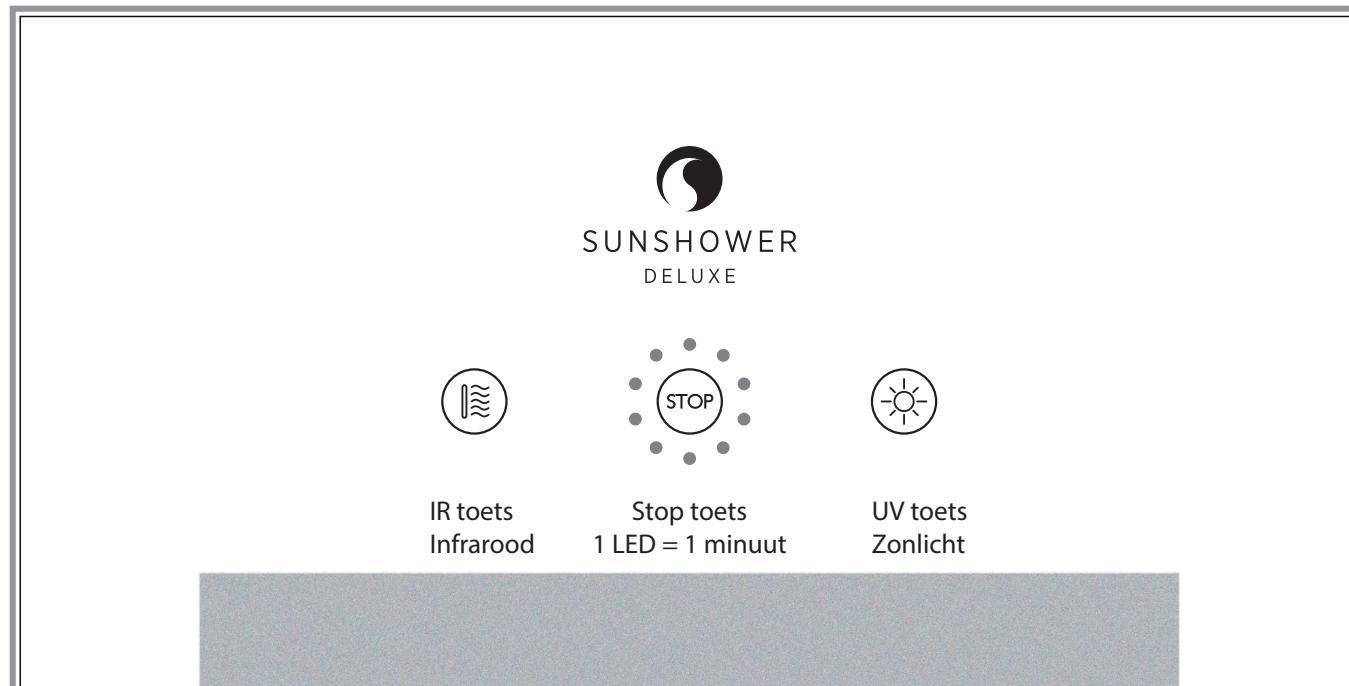

3D Voorbeeld

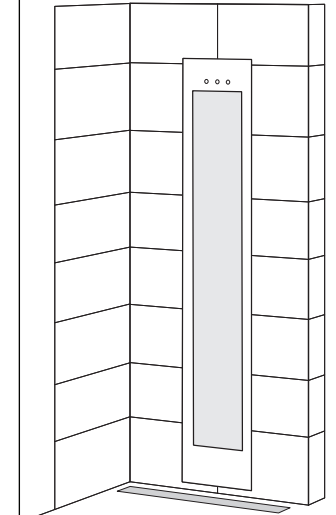

## Instructies

Schakel de groep of aardlekschakelaar in.  
 Druk vervolgens op de UV of IR knop om een sessie te starten.  
 Indien de sunshower geen sessie start controleer of de flatcable, stap 4, goed gemonteerd is.  
 Bij het eindigen van de IR of UV sessie koelt het apparaat 4 minuten na. Dit wordt aangegeven met 4 knipperende ledjes rond de stop knop.