

	L	400	500	600	700	800	900	1000	1100	1200	1400	1600	1800	2000	2200	2400	2600	2800	3000
T11	A	83	100	150	200	250	300	350	400	450	550	650	750	850	950	1050	1150	1250	1350
	B	-	-	-	-	-	-	-	-	-	-	-	17	17	17	17	17	17	17
T21 - T33	A	67	117	167	217	267	317	367	417	467	567	667	767	867	967	1067	1167	1267	1367
	B	-	-	-	-	-	-	-	-	-	-	-	0	0	0	0	0	0	0

H	C	D
300	/	140
400	103	240
500	103	340
600	103	440
700	103	540
900	103	740

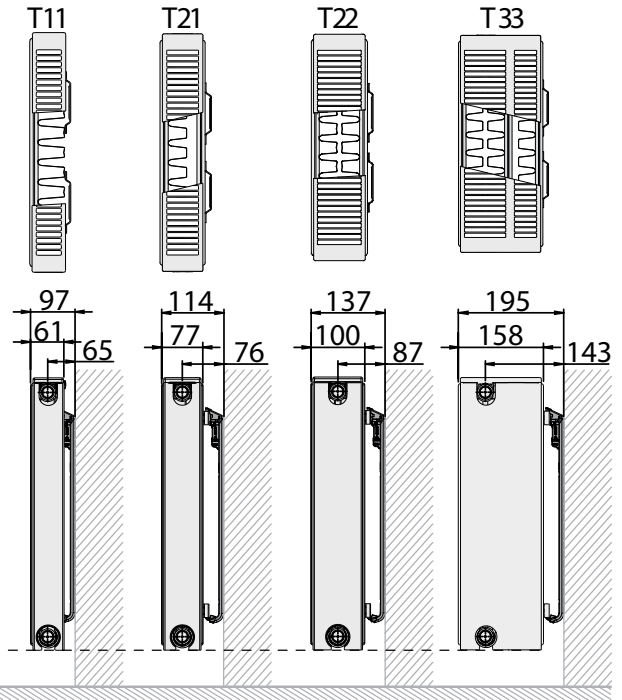

Aantal Consoles volgens VDI 6036 - Nombre de Consoles selon VDI 6036  
 Number of Brackets according to VDI 6036  
 Anzahl der Konsolen nach VDI 6036

Betonnen Muur* - Paroi en Béton* - Concrete Wall* - Betonwand*			
H	300 - 400	500-950	
VDI 6036	class 1-2	class 3	class 1-2-3
L	400	2	2
	500	2	2
	600	2	2
	700	2	2
	800	2	2
	900	2	2
	1000	2	2
	1200	2	2
	1400	2	3**
	1600	2	3**
	1800	3	3
	2000	3	3
	2200	3	4**
	2400	3	4**
	2600	3	4**
	2800	3	4**
	3000	3	4**

(\*): Voor montage in andere wanden:  
 - Mogelijk dienen andere bouten en pluggen gebruikt te worden.  
 - Het aantal consoles om aan de benodigde klasse te voldoen kan veranderen.  
 (\*\*): Bijkomende console(s) vereist om aan klasse 3 te voldoen. Contacteer ons voor meer informatie.  
 (\*): Pour montage dans d'autres parois:  
 - Il peut être nécessaire d'utiliser d'autres vis et chevilles.  
 - Le nombre de consoles pour être conforme à la classe requise peut varier.  
 (\*\*): Console(s) supplémentaire(s) nécessaire(s) pour être conforme à la classe 3. Veuillez nous contacter pour plus d'informations.  
 (\*): For mounting in other types of walls:  
 - It may be necessary to use other screws and plugs.  
 - The number of brackets may vary in order to fulfill class 3.  
 (\*\*): Additional bracket(s) required to fulfill class 3. Contact us for more information.  
 (\*): andere Wandmateriale:  
 - andere Schrauben und Dübel sind möglicherweise erforderlich  
 - die Anzahl der notwendigen Konsolen zur Erfüllung der Anforderungen der Klasse kann sich ändern  
 (\*\*): zusätzliche Console(n) sich erforderlich zur Erfüllung der Anforderungen von Klasse 3. Wir stehen zur Verfügung für weitere Informationen

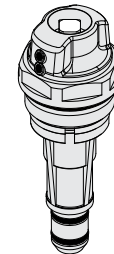
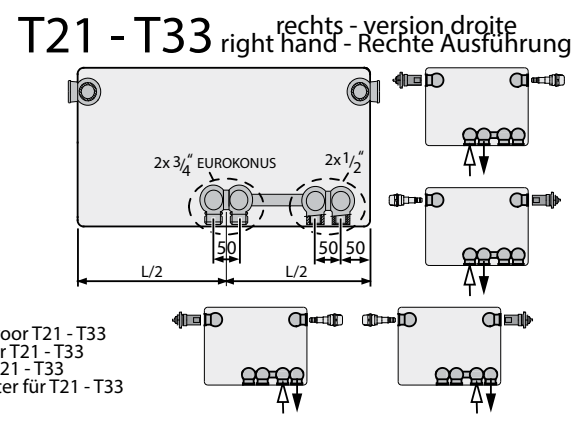
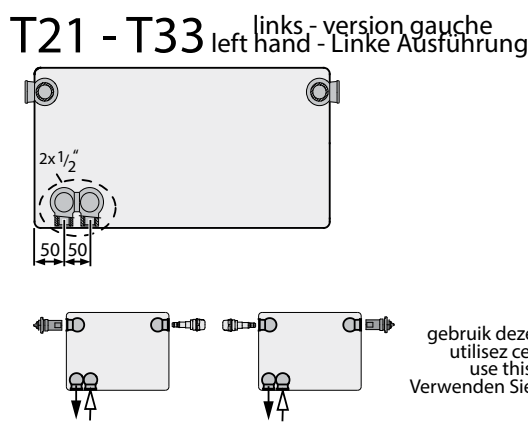
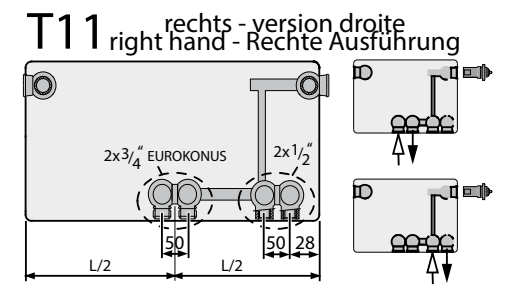
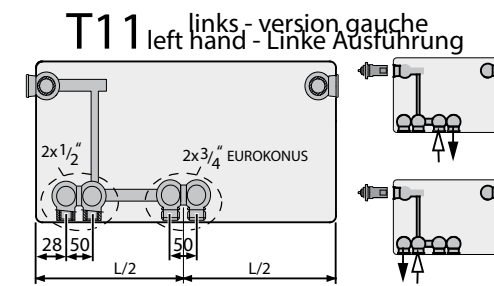

gebruik deze ontlufter voor T21 - T33  
 utilisez ce purgeur pour T21 - T33  
 use this air vent for T21 - T33  
 Verwenden Sie diese Entlüfter für T21 - T33

① \*L >= 1800



4x (\*6x)  
2x (\*3x)  
2x (\*3x)

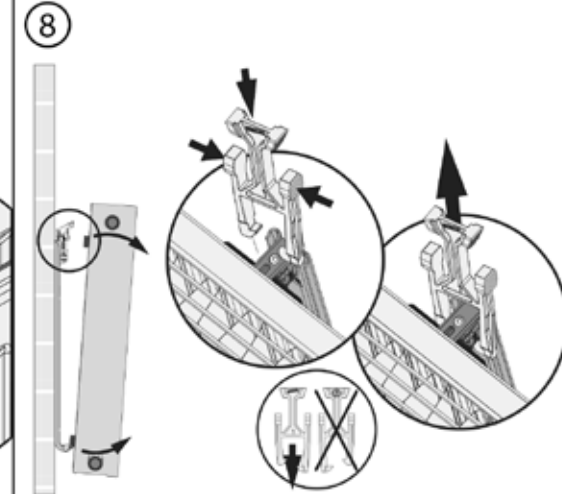
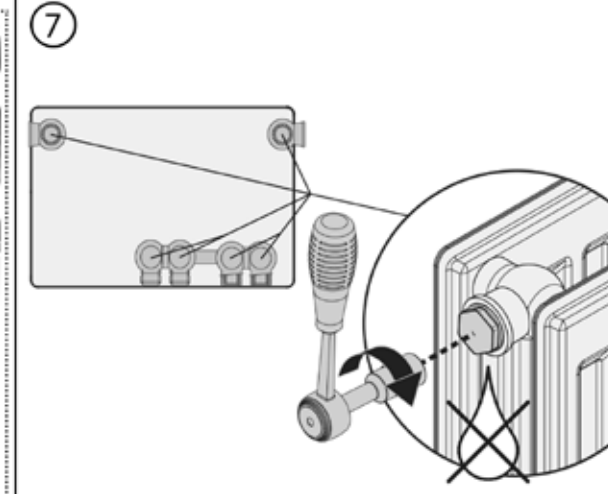
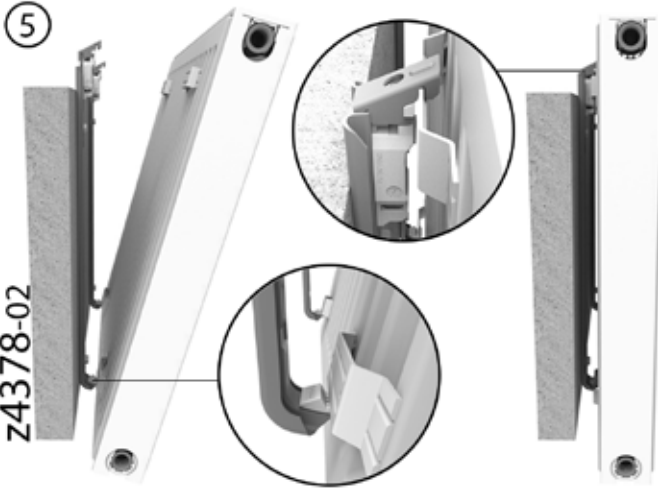
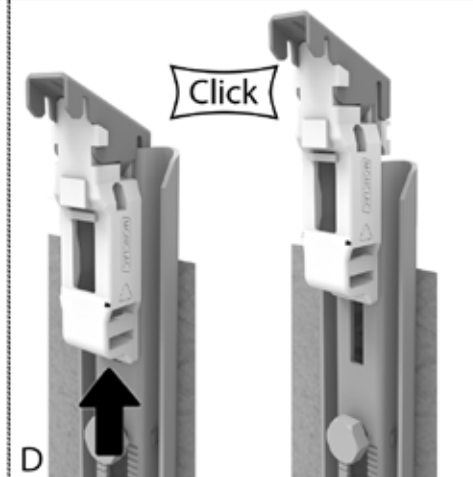
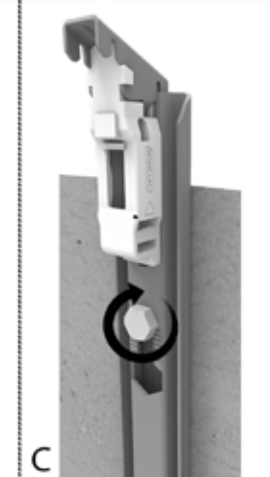
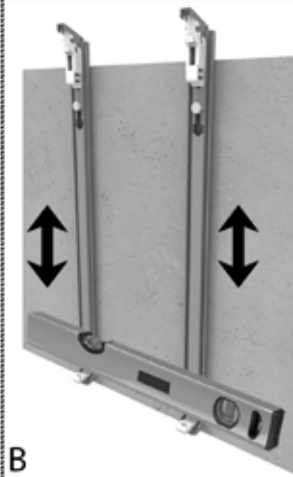
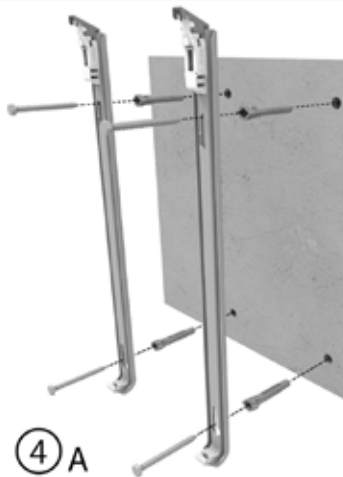
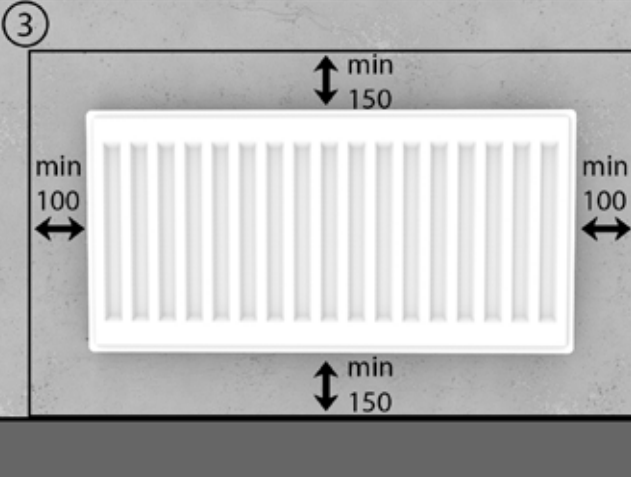
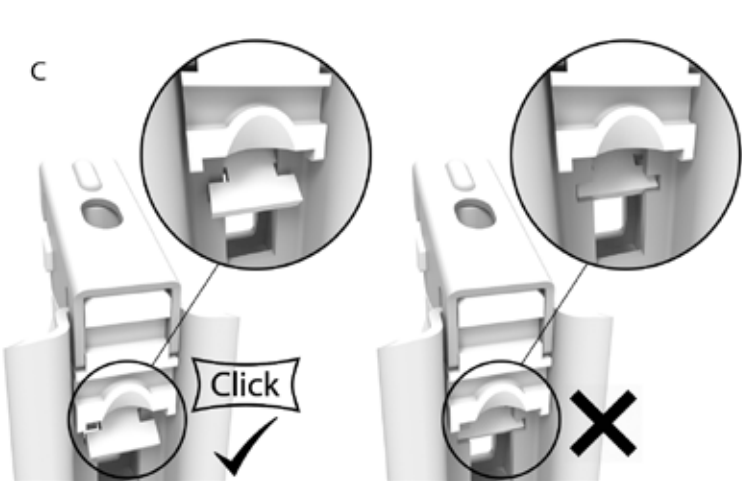
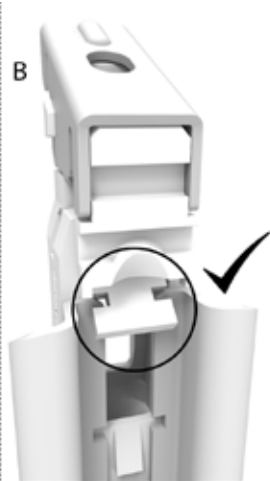

Z4378-02