

PRODUCT DATA SHEET



PRODUCT CODE

GL0510SIW+

RANGE

GLIDE II

DESCRIPTION

500mm Basin 0TH Ice White

COLOUR Ice White

MATERIAL Glass

STANDARDS EN 31
EN 14688 - CLO

INSTALLATION TYPE Furniture Mounted

CAPACITY OF WATER AT OVERFLOW LEVEL 15 L

BASIN WASTE SIZE 45mm

TAP HOLES 0TH

OVERFLOW Yes

WEIGHT 7kg

WARRANTY 10 Years

TECHNICAL DIMENSIONS

Dimensions in mm unless otherwise specified.

Tolerances (per material type) apply.

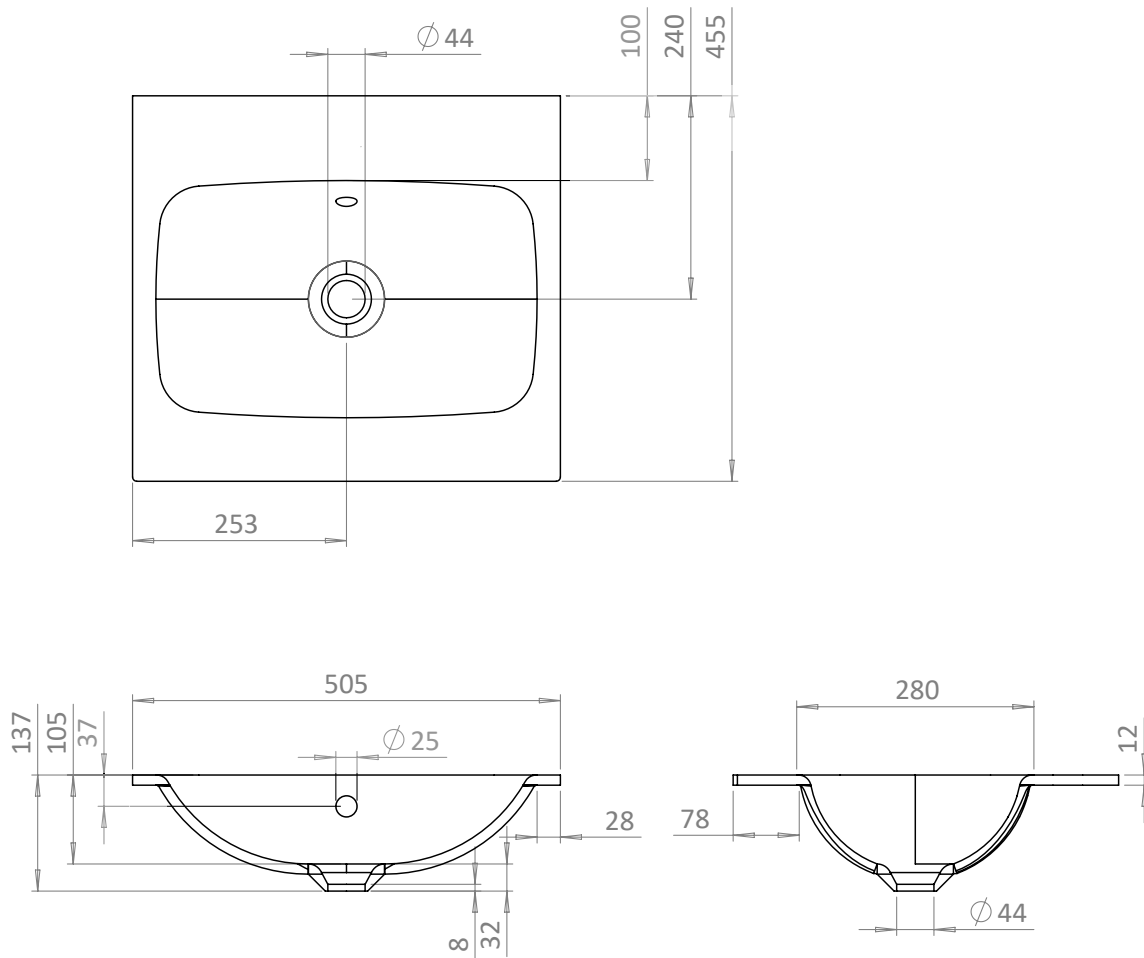

V10522