









1	2	3	4	5	6	7	8	9	10	11
BODY	CARTRIDGE	CART. NUT	CART. CAP	HANDLE	SETSCREW	INDEX	BASE	BASE O-RING	SPOUT	UPPER SEALING
										
GÖVDE	KARTUŞ	TESPİT SOMUNU	KAR. KAPAÇI	KUM. KOLU	SETSKUR VİDA	İNDEKS	ALT TABAN	ALT TBAN ORING	PULL-OUT BORU	ÜST TEFLON
2040302.02	2010551.00	6012805.00	9013503.09	2014950.02	5012851.05	2017751.09	2062105.02	6012852.00	2041480.02	5021354.00

12	13	14	15	16	17	18	19	20	21	22
O-RING	LOWER SEALING	HANDSHOWER SEALING	HANDSHOWER	CONNECTION TUBE	FLEX HOSE	HANDSHOWER NUT	FLEX HOSE	WEIGHT	SET SCREW	FIXING KIT
										
ORING	ALT TEFLON	EL DUŞU DESTEK PARÇASI	EL DUŞU	BAĞLANTI BORUSU	FLEX HORTUM	EL DUŞU SOMUNU	FLEX HORTUM	PULL-OUT AĞIRLIK	ROTASYON VIDASI	ALT BAĞLANTI TAKIMI
5021355.00	5021356.00	1012855.00	2041550.02	5021309.00	1012889.00	1012807.09	6711853.00	5021360.00	5021353.05	2041585.00

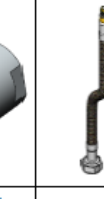
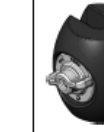
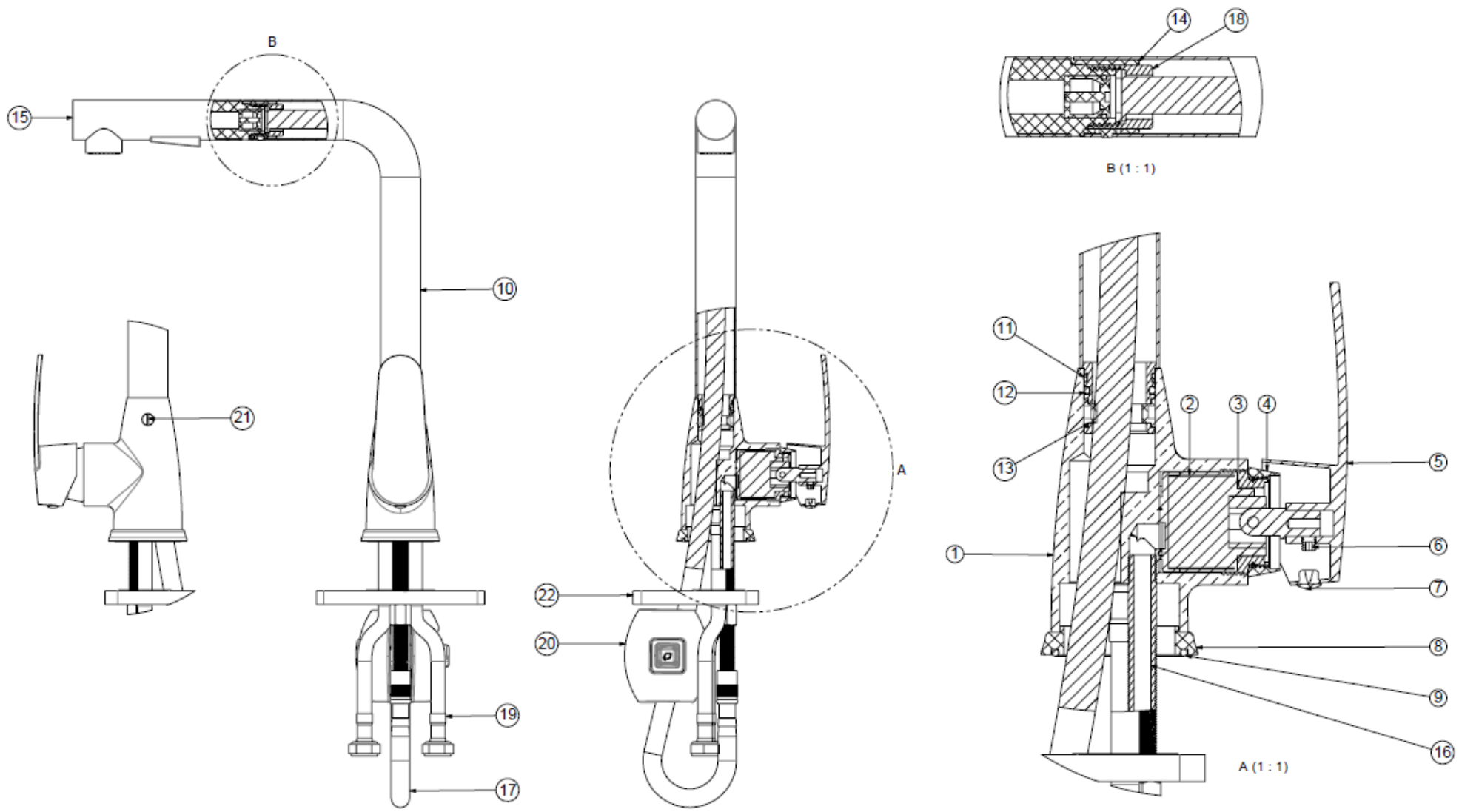

PLIEGER