

PRODUCT DATA SHEET



PRODUCT CODE

VG7000DWM

RANGE

VERGO

DESCRIPTION

Basin Unit 700mm White Matt

COLOUR	White Matt
COLOUR CODE/ REFERENCE	Crosswater Exclusive
MATERIAL	MDF
STANDARDS	EN 13986 EN 14749
INSTALLATION TYPE	Wall-Mounted
DRAWER BOX	Metal Drawer Box
DRAWER RUNNERS	InnoTech Atira - Soft Close, Pull To Open
DRAWER EXTENSION	Full Extension
DRAWER ADJUSTMENT	3 Way
DRAWER CAPACITY	30kg
WALL HANGERS	InnoTech Atira - Factory Fitted 100kg Load Capacity Per Pair On A Solid Wall 2 Way Adjustment
ADJUSTABLE FEET	No
WEIGHT	21kg
WARRANTY	10 Years

TECHNICAL DIMENSIONS

Dimensions in mm unless otherwise specified.

Tolerances (per material type) apply.

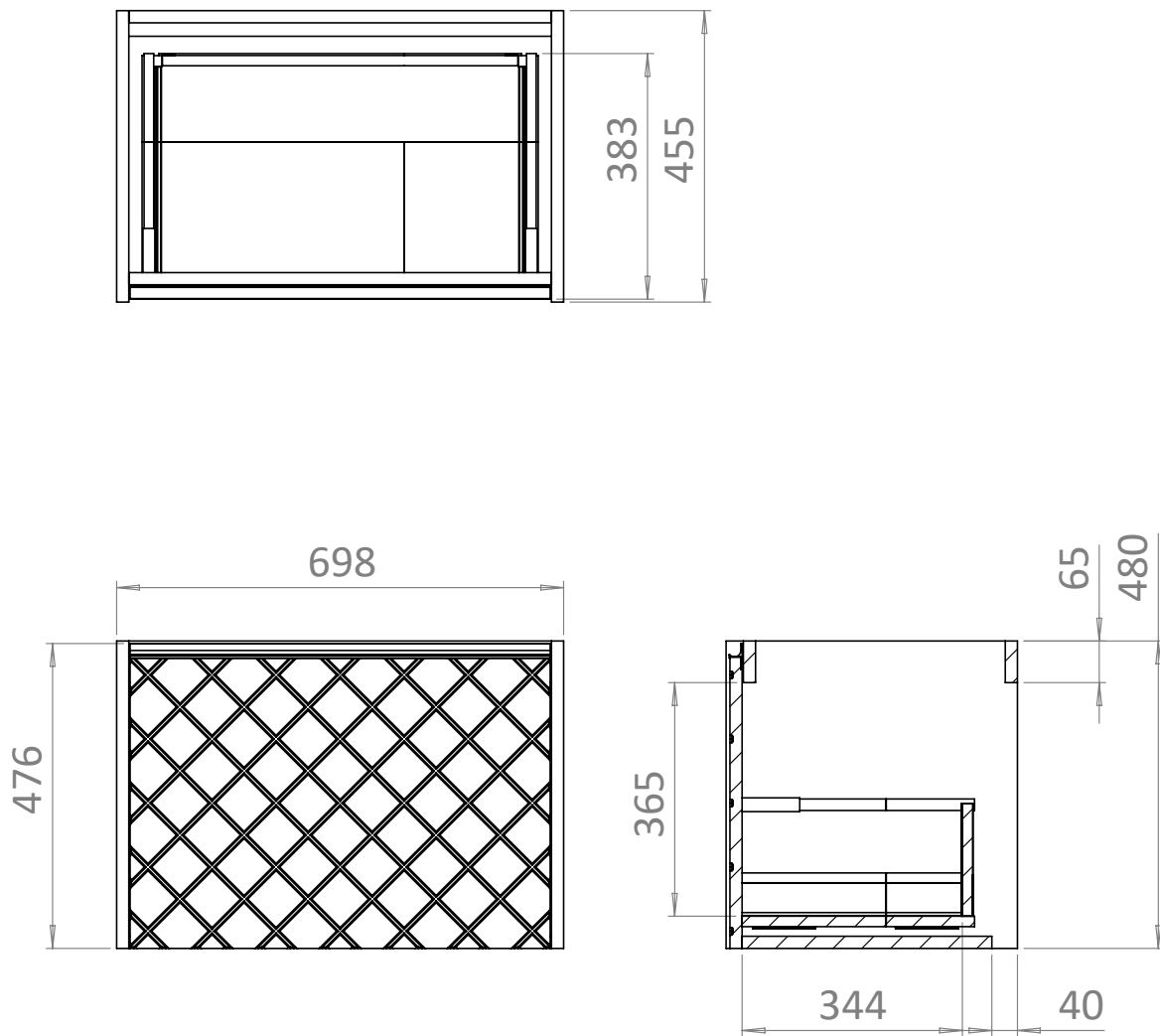

V10522

SPARES DIAGRAM

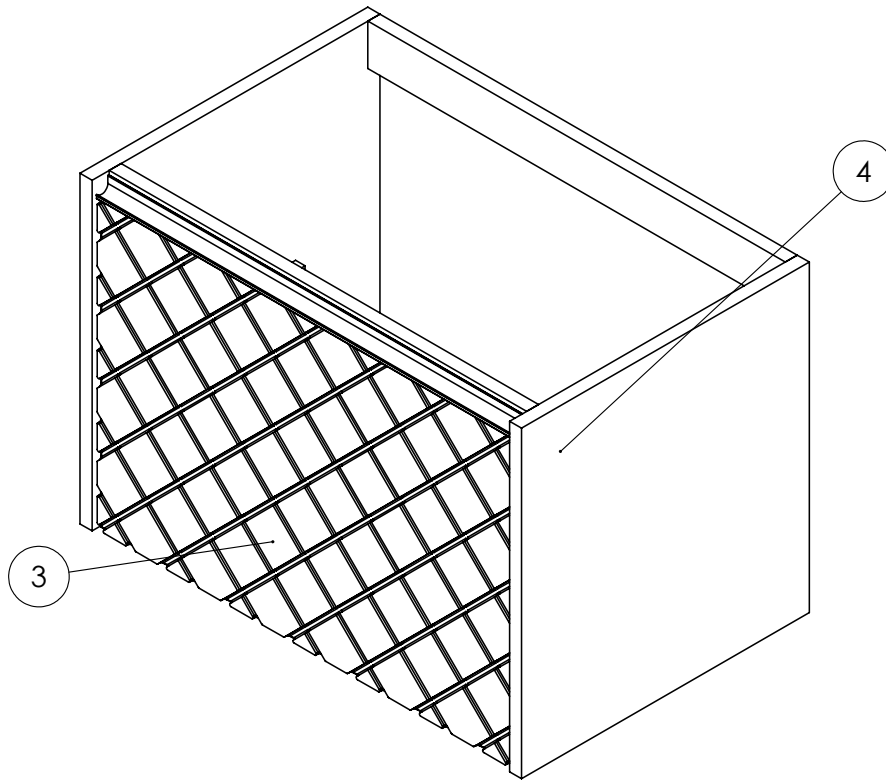

NUMBER	PART CODE	DESCRIPTION
1	RUNNERSVERGO	Vergo Set of Drawer Runners x2 All Units
2	WBRACKETSVERGO	Vergo Wall Brackets x2
3	TDF_VG700DWM	Vergo Drawer Front Only for VG700DWM
	TDF_VG700DBM	Vergo Drawer Front Only for VG700DBM
	TDF_VG700DMS	Vergo Drawer Front Only for VG700DMS
4	DRAWER_VG700Dxx	Vergo Drawer Box Complete No Front VG700Dxx

Only the parts labelled are available as spares.

V10522