

INSTALLATIE VOORSCHRIFT

20.3789

1000x2020mm
(990-1010) x2020mm

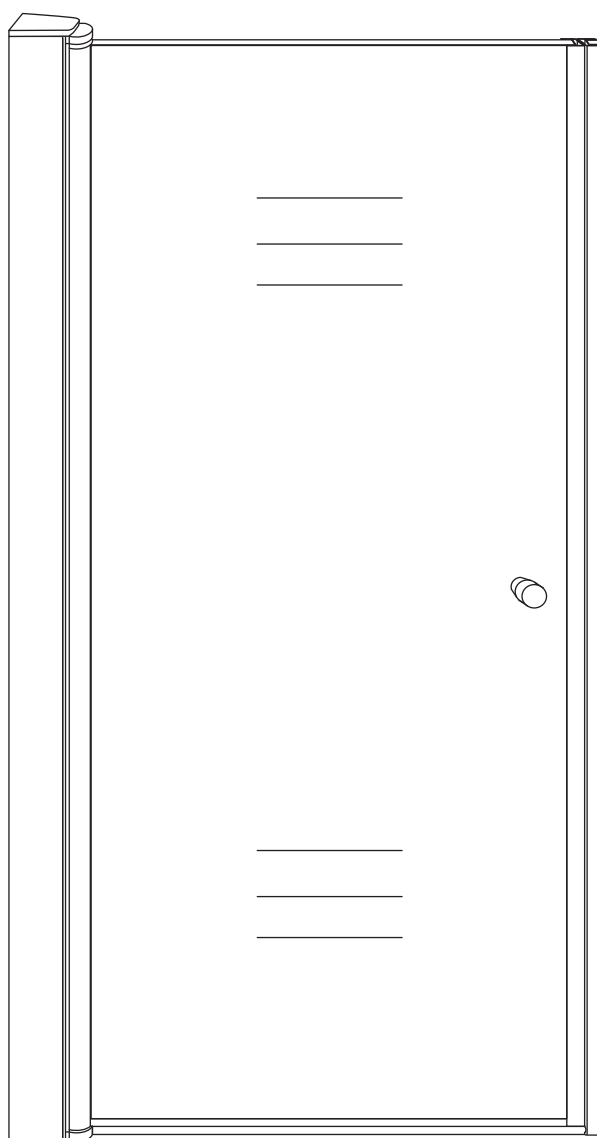

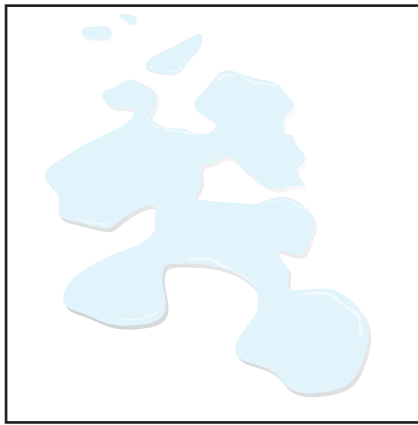

Zonder NANO

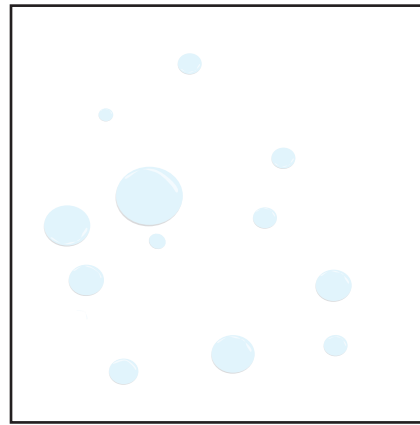

NANO



beide zijden NANO behandeld

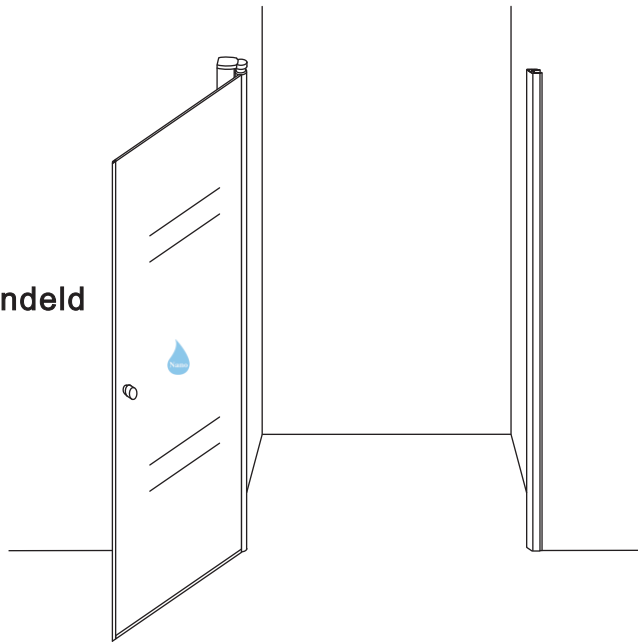

beide zijden NANO behandeld

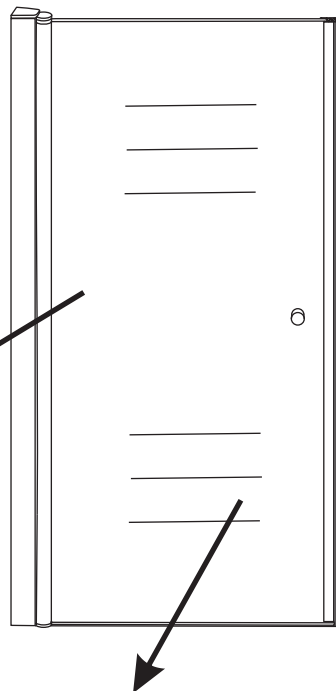

NANO garantie: 2 jaar bij normaal gebruik
LET OP: gebruik geen grove scherpe voorwerpen, zoals schuursponsjes of staalwol om het glas schoon te maken.



1

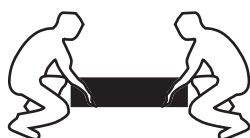

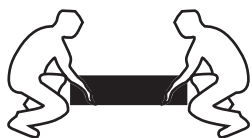
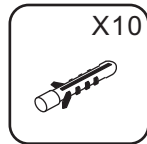
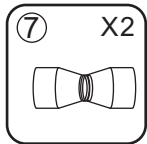
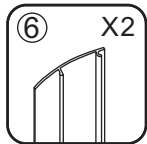
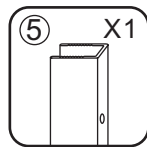
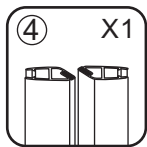
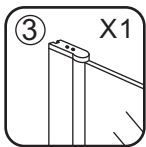
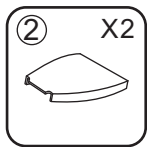
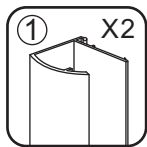
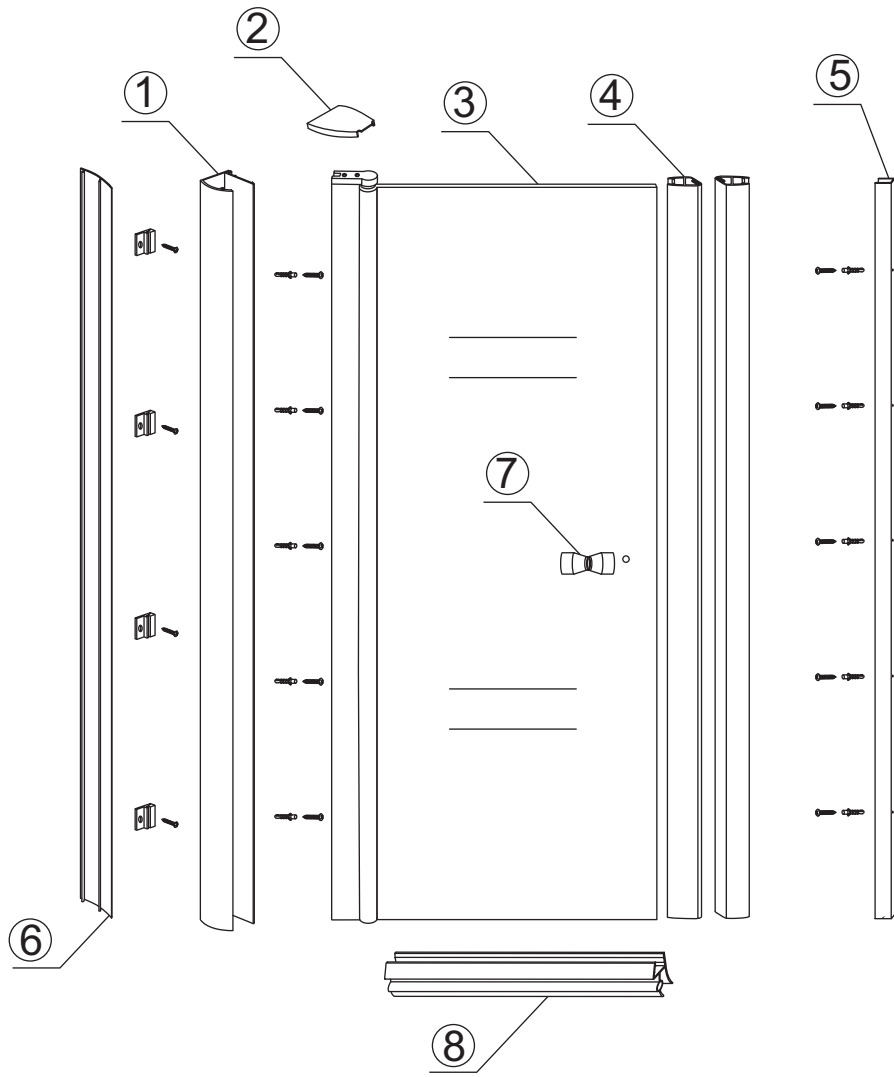

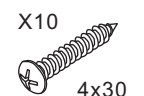
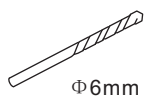
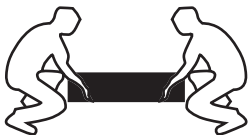
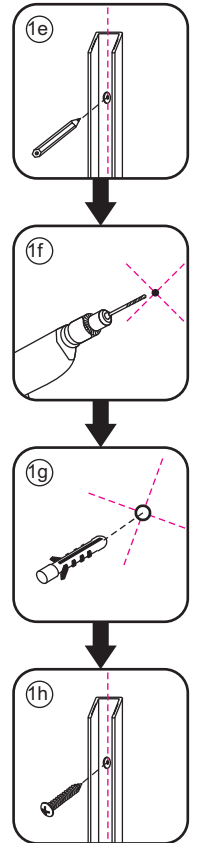
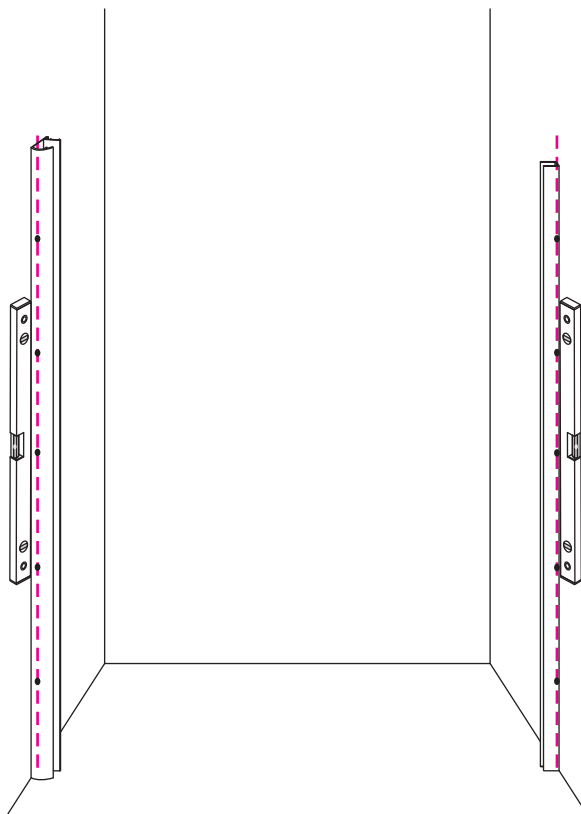
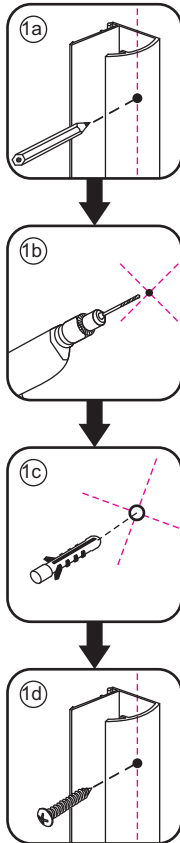
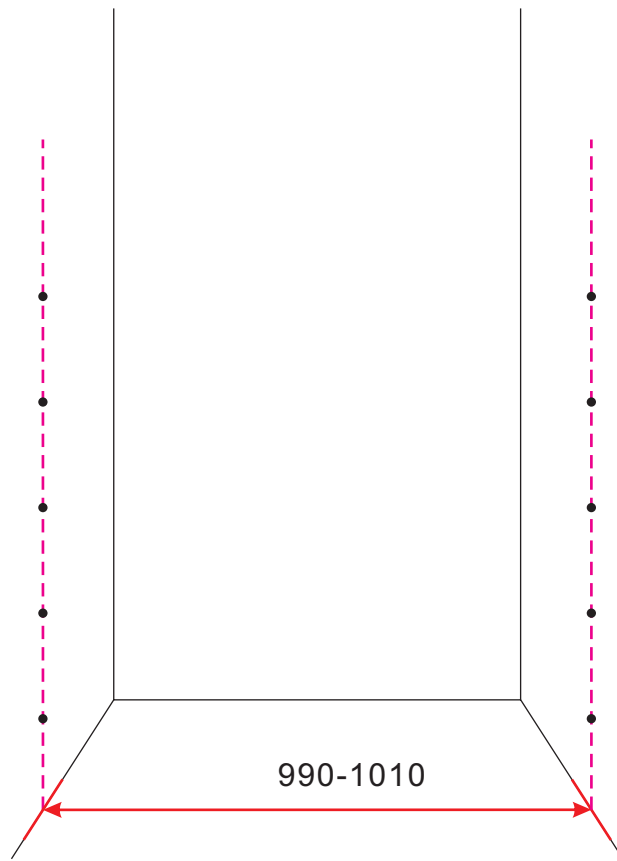

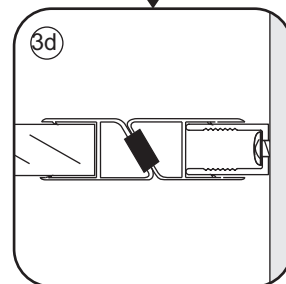
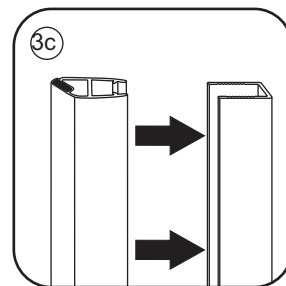
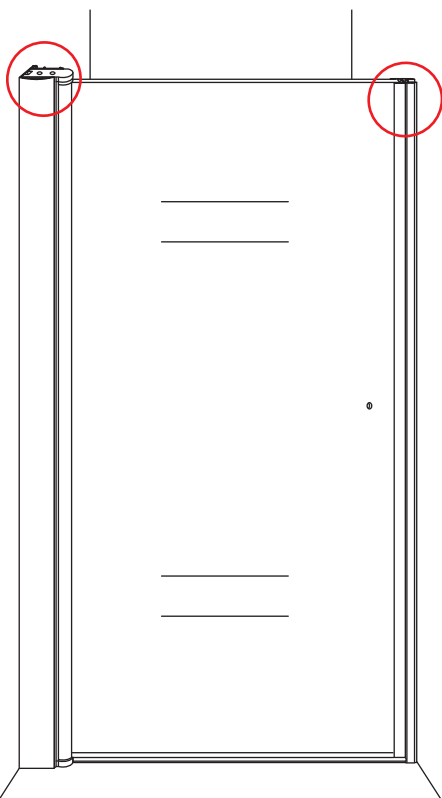
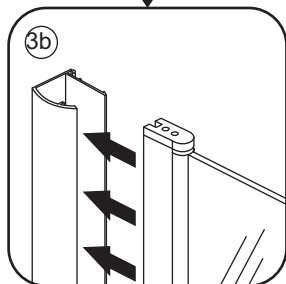
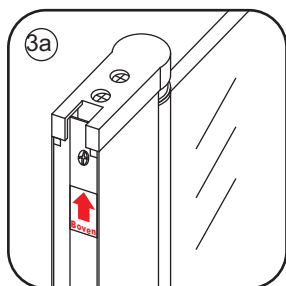
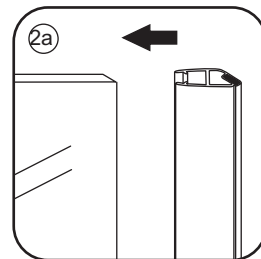
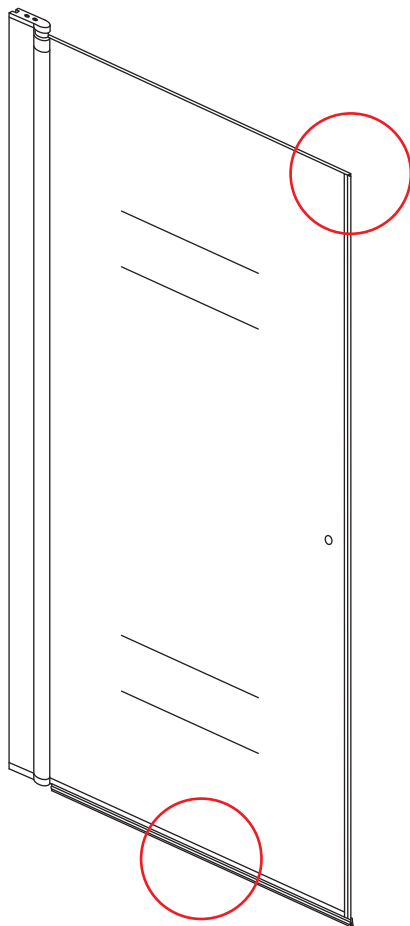
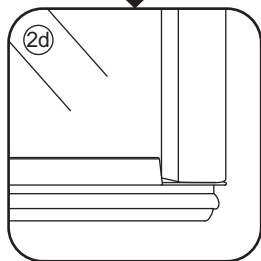
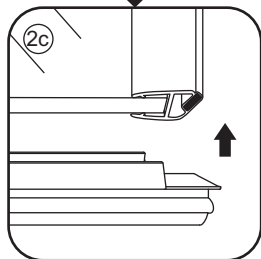
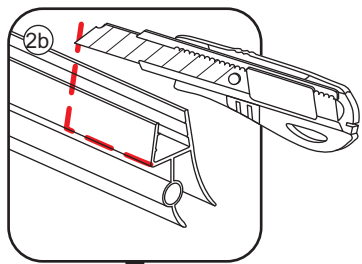

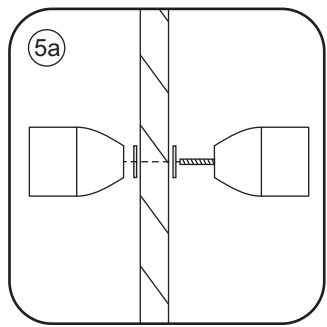
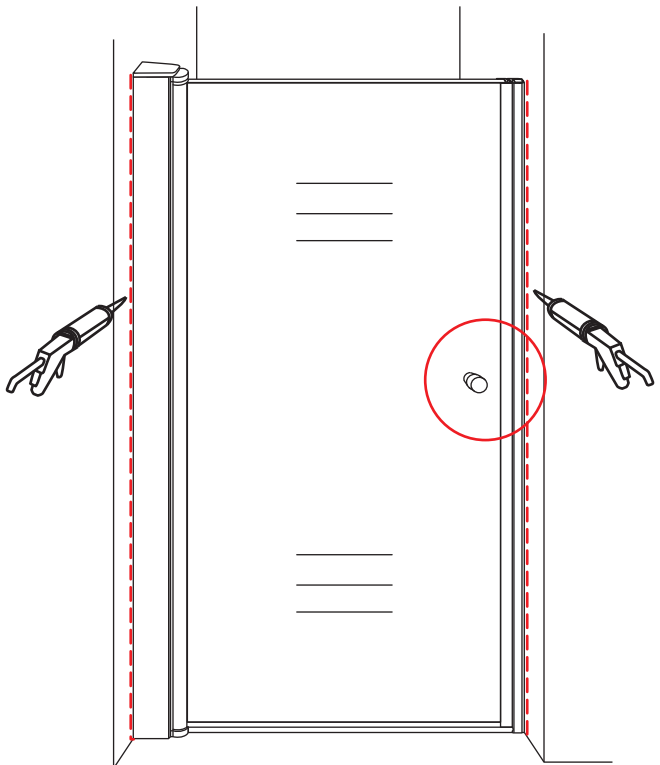
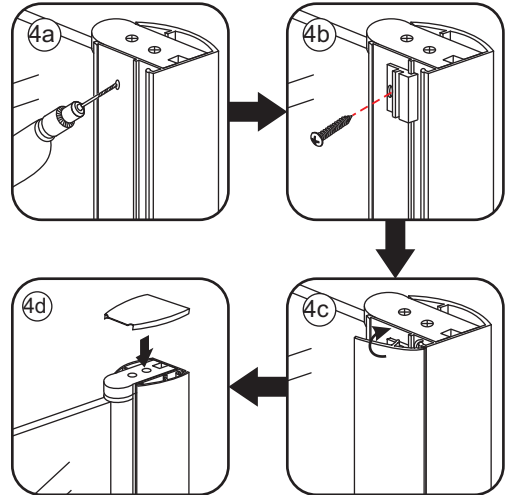
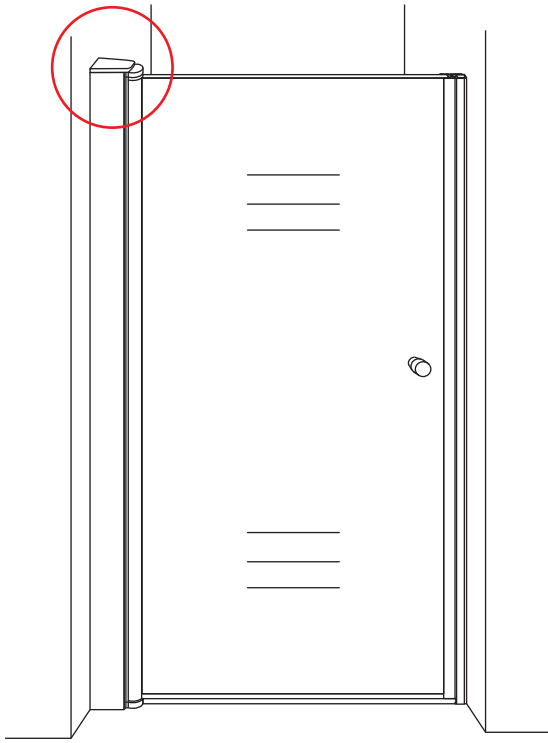

Voorzie beide kanten van het muurprofiel (binnen- en buitenkant) van siliconenkit.

